

JVC

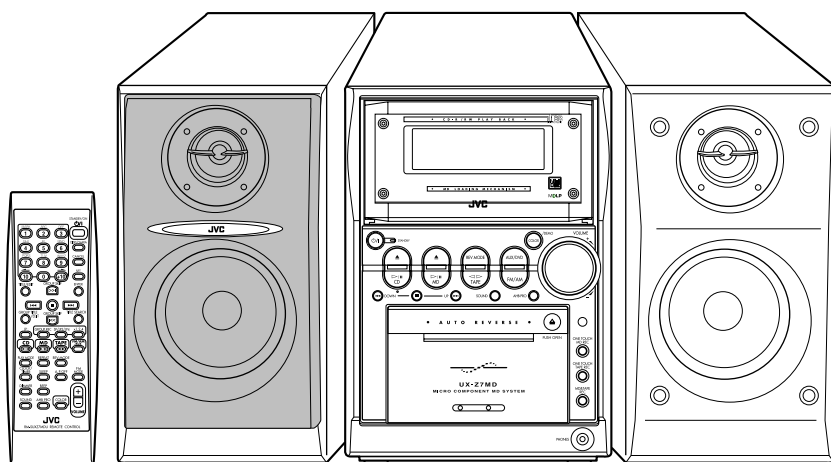

MICRO COMPONENT MD SYSTEM

UX-Z7MD

—Consists of CA-UXZ7MD and SP-UXZ7MD

MDLP



INSTRUCTIONS

For Customer Use:

Enter below the Model No. and Serial No. which are located either on the rear, bottom or side of the cabinet. Retain this information for future reference.

Model No. _____

Serial No. _____

LVT0900-008A

[A]

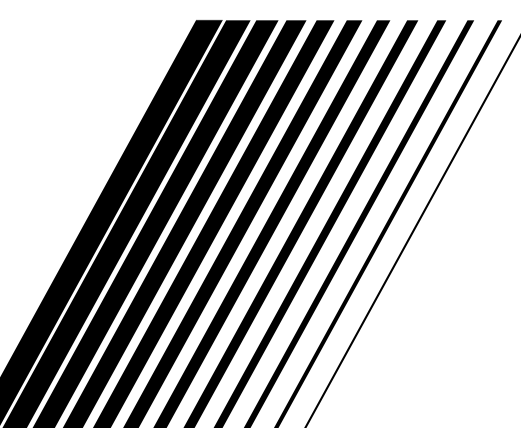

Warnings, Cautions and Others

Caution— button!

Disconnect the mains plug to shut the power off completely. The  button in any position does not disconnect the mains line. The power can be remote controlled.

CAUTION

To reduce the risk of electrical shocks, fire, etc.:

1. Do not remove screws, covers or cabinet.
2. Do not expose this appliance to rain or moisture.

CAUTION

- Do not block the ventilation openings or holes.
(If the ventilation openings or holes are blocked by a newspaper or cloth, etc., the heat may not be able to get out.)
- Do not place any naked flame sources, such as lighted candles, on the apparatus.
- When discarding batteries, environmental problems must be considered and local rules or laws governing the disposal of these batteries must be followed strictly.
- Do not expose this apparatus to rain, moisture, dripping or splashing and that no objects filled with liquids, such as vases, shall be placed on the apparatus.

IMPORTANT FOR LASER PRODUCTS

REPRODUCTION OF LABELS

① CLASSIFICATION LABEL ON EXTERIOR SURFACE

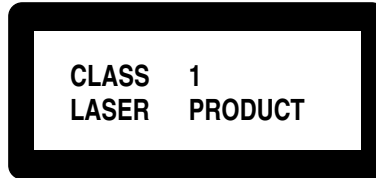

② WARNING LABEL INSIDE THE UNIT

CAUTION: Invisible laser radiation when open and interlock failed or defeated. AVOID DIRECT EXPOSURE TO BEAM. (e)	ADVARSEL: Usynlig laserstråling ved åbning, når sikkerhedsafbrydere er ude af funktion. Undgå udsættelse for stråling (d)	WARNING: Osynlig laserstråling når denna del är öppnad och spärren är urkopplad. Betrakta ej strålen. (s)	VARO: Avattaessa ja suojalukitus ohitettaessa olet alltiina näkymättömälle lasersäteilylle. Älä katso säteeseen. (f)
--	--	--	---

1. CLASS 1 LASER PRODUCT
2. **CAUTION:** Invisible laser radiation when open and interlock failed or defeated. Avoid direct exposure to beam.
3. **CAUTION:** Do not open the top cover. There are no user serviceable parts inside the Unit; leave all servicing to qualified service personnel.

Caution: Proper Ventilation

To avoid risk of electric shock and fire, and to prevent damage, locate the apparatus as follows:

- 1 Front: No obstructions and open spacing.
- 2 Sides/ Top/ Back: No obstructions should be placed in the areas shown by the dimensions below.
- 3 Bottom: Place on the level surface. Maintain an adequate air path for ventilation by placing on a stand with a height of 10 cm or more.

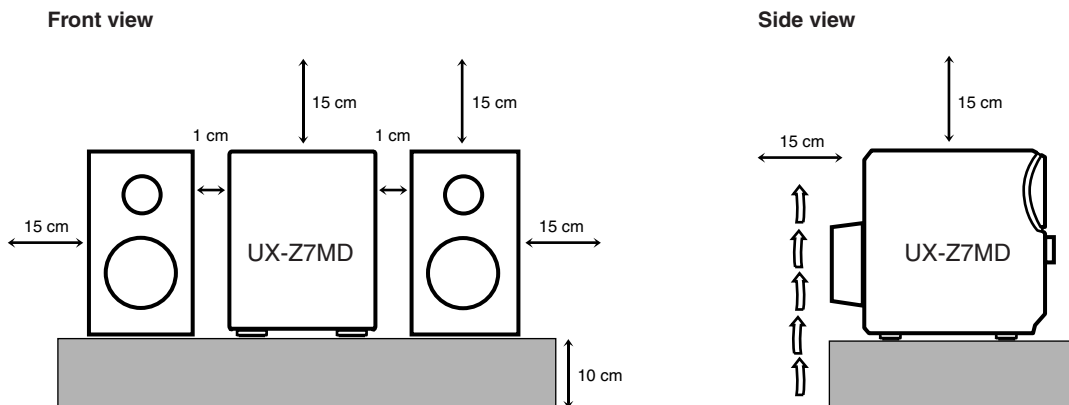



Introduction

We would like to thank you for purchasing one of our JVC products. Before operating this unit, read this manual carefully and thoroughly to obtain the best possible performance from your unit, and retain this manual for future reference.

About This Manual

This manual is organized as follows:

- This manual mainly explains playback and editing operations using the remote control, and the other operation such as recording operations using the buttons on the main unit.
You can use the buttons both on the remote control and on the main unit for the same operations if they have the same or similar names (or marks), unless mentioned otherwise.
- Basic and common information that is the same for many functions is grouped in one place, and is not repeated in each procedure. For instance, we do not repeat the information about turning on/off the unit, setting the volume, changing the sound effects, and others, which are explained in the section “Basic and Common Operations” on pages 10 – 15.
- The following marks are used in this manual:

	Gives you warning and caution to prevent from damage or risk of fire/electric shock. Furthermore, gives you information which is not good for obtaining the best possible performance from the unit.
	Gives you information and hints you had better know.

Precautions

Installation

- Install in a place which is level, dry and neither too hot nor too cold—between 5°C and 35°C.
- Install the unit in a location with adequate ventilation to prevent internal heat buildup in the unit.
- Leave sufficient distance between the unit and the TV.
- Keep the speakers away from the TV to avoid interference with TV.

 DO NOT install the unit in a location near heat sources, or in a place subject to direct sunlight, excessive dust or vibration.

Power sources

- When unplugging the unit from the wall outlet, always pull the plug, not the AC power cord.



DO NOT handle the AC power cord with wet hands.

Moisture condensation

Moisture may condense on the lenses inside the unit in the following cases:

- After starting heating in the room
 - In a damp room
 - If the unit is brought directly from a cold to a warm place
- Should this occur, the unit may malfunction. In this case, leave the unit turned on for a few hours until the moisture evaporates, unplug the AC power cord, then plug it in again.

Others

- The electronic swing panel may malfunction when you use this unit under the strong light such as the sunlight.



DO NOT expose this unit to the strong light.

- Should any metallic object or liquid fall into the unit, unplug the AC power cord and consult your dealer before operating any further.
- If you are not going to operate the unit for an extended period of time, unplug the AC power cord from the wall outlet.



DO NOT disassemble the unit since there are no user serviceable parts inside.

If anything goes wrong, unplug the AC power cord and consult your dealer.

Contents

Location of the Buttons	3	Recording	33
Main Unit	3	Before You Start Recording on an MD	34
Remote Control	5	Setting MD Recording Modes	36
Getting Started	6	Recording CD onto an MD—CD Synchronized Recording	36
Unpacking	6	Recording Other Sources onto an MD	37
Connecting Antennas	6	Before You Start Recording on a Tape	38
Connecting Speakers	7	Recording onto a Tape	39
Connecting External Equipment	8	Recording CD onto an MD and a Tape —CD Synchronized Recording	40
Putting the Batteries into the Remote Control	9	Editing MDs	41
Basic and Common Operations	10	Guidance—MD Group Functions	42
Turning On the Power	11	Introducing Group Editing Functions	43
Setting the Auto Power Off	11	Forming a Group—FORM GR	44
Turning On/Off the Key-touch Tone	11	Adding a Track to a Group—ENTRY GR	45
Setting the Clock	12	Dividing a Group—DIVIDE GR	46
Selecting the Sources and Starting Play	13	Joining Two Groups—JOIN GR	47
Adjusting the Volume	13	Moving a Group—MOVE GR	48
Reinforcing the Bass Sound	14	Ungrouping Tracks—UNGROUP	49
Selecting the Sound Modes	14	Dissolving All Groups—UNGR ALL	49
Setting the Display Illumination	15	Erasing Tracks in a Group—ERASE GR	50
Listening to FM and AM Broadcasts	16	Introducing Track Editing Functions	51
Tuning in to a Station	17	Dividing a Track—DIVIDE	52
Presetting Stations	18	Joining Two Tracks—JOIN	53
Tuning in to a Preset Station	18	Moving a Track—MOVE	54
Playing Back CDs (CD-R/CD-RW)	19	Erasing Tracks—ERASE	55
Precautions on CD Playback	20	Erasing All Tracks—ALL ERASE	55
Playing Back the Entire CD—Normal Play	20	Assigning Titles to an MD	56
Basic CD Operations	21	Using the Timers	59
Programming the Playing Order of the Tracks —Program Play	21	Using Recording Timer	60
Playing at Random—Random Play	22	Using Daily Timer	61
Repeating Tracks—Repeat Play	22	Using Sleep Timer	63
Playing Back MDs	23	Timer Priority	63
Playing Back the Entire MD—Normal Play	24	Maintenance	64
Basic MD Operations	24	Additional Information	65
Programming the Playing Order of the Tracks —Program Play	25	MD Disc Types	65
Playing at Random—Random Play	26	ATRAC (Adaptive TRansform Acoustic Coding)/ ATRAC3 (MDLP)	65
Playing Tracks in a Group—Group Play	27	UTOC (User Table Of Contents)	65
Repeating Tracks—Repeat Play	27	Sound Skip Guard Memory	65
Searching for Tracks to Play —MD Title Search	28	SCMS (Serial Copy Management System)	66
.....	28	HCMS (High-speed Copy Management System) ..	66
.....	28	• MD limitations	66
Playing Back Tapes	29	CD/MD Messages	67
Playing Back a Tape	30	Troubleshooting	69
Listening to External Equipment	31	Specifications	70
Listening to External Equipment	32		
Adjusting the Audio Input Level	32		

Location of the Buttons

Become familiar with the buttons on your unit.

Main Unit

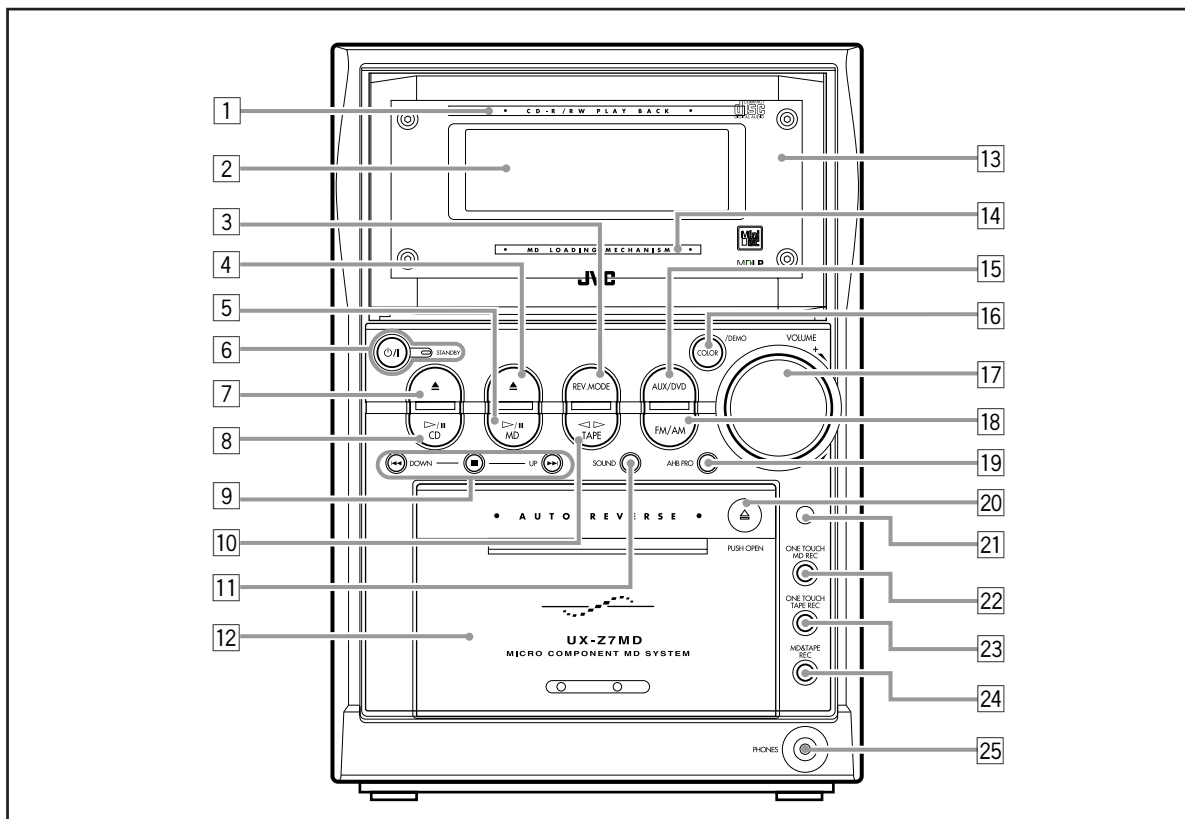

Main unit

See pages in the parentheses for details.



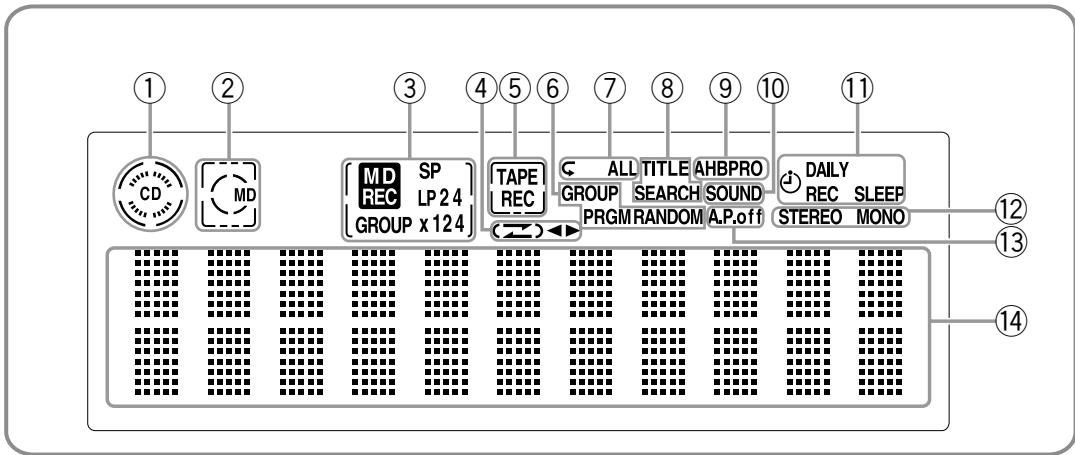

- | | |
|--|---|
| <p>1 Disc tray (20)</p> <p>2 Display window (4)</p> <p>3 REV.MODE button (25, 30, 39, 40)</p> <p>4 MD ▲ (eject) button (11, 24, 26, 58)
• Pressing this button also turns on the unit.</p> <p>5 MD ▷/ (play/pause) button (11, 13, 24)
• Pressing this button also turns on the unit.</p> <p>6 ⏻/I (Standby/On) button and STANDBY lamp (11, 61, 62)</p> <p>7 CD ▲ (eject) button (11, 20, 22)
• Pressing this button also turns on the unit.</p> <p>8 CD ▷/ (play/pause) button (11, 13, 20, 21)
• Pressing this button also turns on the unit.</p> <p>9 Multi operation buttons
• DOWN and UP buttons
• ◀◀ (reverse search/fast-wind to the left), ■ (stop) and ▶▶ (forward search/fast-wind to the right) buttons</p> | <p>10 TAPE ◀▷ (play) button (11, 13, 30)
• Pressing this button also turns on the unit.</p> <p>11 SOUND button (14)</p> <p>12 Cassette holder (30)</p> <p>13 Electronic swing panel</p> <p>14 MD loading slot (24)</p> <p>15 AUX/DVD button (11, 13, 32)
• Pressing this button also turns on the unit.</p> <p>16 COLOR/DEMO button (9, 15)</p> <p>17 VOLUME + / – control (13)</p> <p>18 FM/AM button (11, 13, 17, 18)
• Pressing this button also turns on the unit.</p> <p>19 AHB PRO (Active Hyper Bass PRO) button (14)</p> <p>20 ▲ (PUSH OPEN) (30)
• Pushing on this mark opens and closes the cassette holder.</p> <p>21 Remote sensor</p> <p>22 ONE TOUCH MD REC button (36, 37)</p> <p>23 ONE TOUCH TAPE REC button (39)</p> <p>24 MD&TAPE REC button (40)</p> <p>25 PHONES jack (13)</p> |
|--|---|

Display window on the electronic swing panel



Display window

See pages in the parentheses for details.

- ① CD indicator (21)
- ② MD indicator (25)
- ③ MD recording indicators
 - MD REC indicator (36, 37, 40, 44 – 50, 52 – 55)
 - Recording length mode indicators (36)
SP, LP2 and LP4
 - Recording speed indicators (36)
x1, x2 and x4
 - Group recording indicator (36)
GROUP
- ④ Tape operation indicators (30, 39, 40)
 -  (reverse mode) and  (tape direction)
- ⑤ TAPE indicator (30)
REC indicator (39, 40)
- ⑥ CD/MD play mode indicators (21, 22, 25 – 27)
 - GROUP, PRGM (program) and RANDOM
- ⑦ CD/MD repeat mode indicators (22, 27)
 -  and  ALL
- ⑧ TITLE SEARCH indicator (28)
- ⑨ AHBPRO (Active Hyper Bass PRO) indicator (14)
- ⑩ SOUND indicator (14)
- ⑪ Timer mode indicators
 -  (timer) (60 – 63)
 - DAILY (Daily Timer) (61, 62)
 - REC (Recording Timer) (60, 61)
 - SLEEP (Sleep Timer) (63)
- ⑫ FM mode indicators (17)
 - STEREO and MONO
- ⑬ A.P.off (Auto Power off) indicator (11)
- ⑭ Main display
 - Shows the source name and other information.

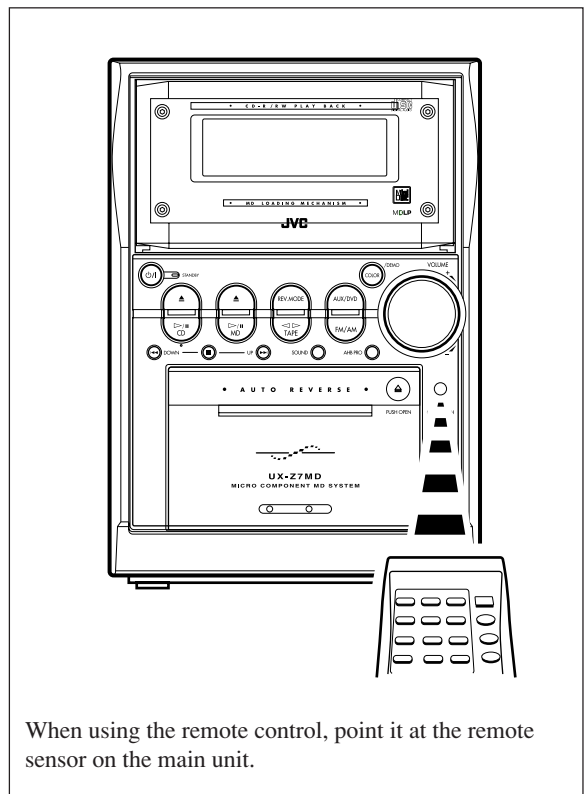

When using the remote control, point it at the remote sensor on the main unit.

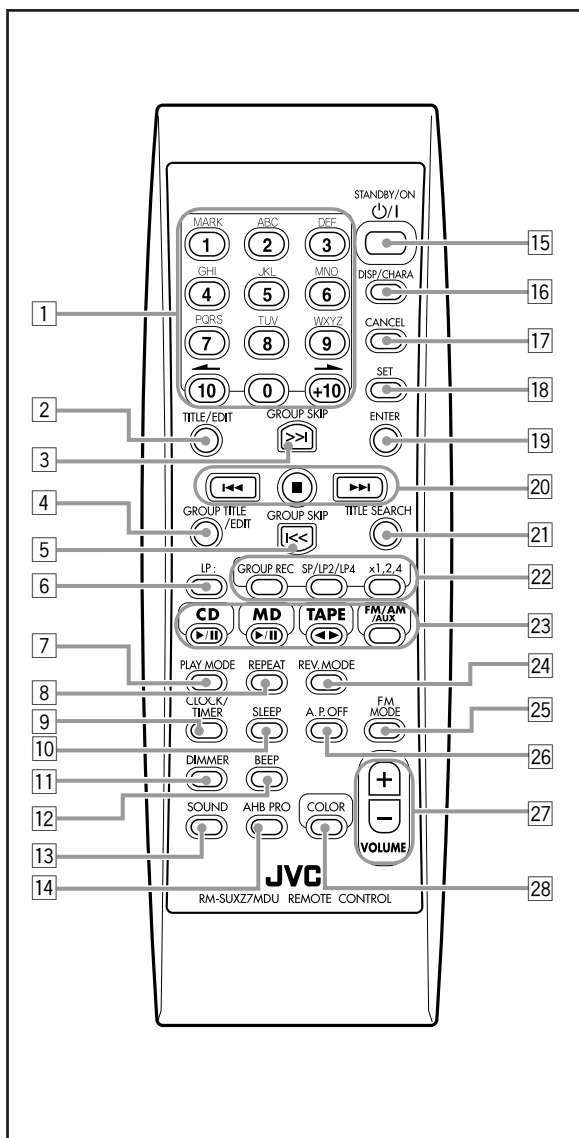

Remote Control

- 1 Number buttons
 - 1 – 10, 0 and +10 buttons (12, 18, 21, 25, 26, 44 – 46, 52 – 55)
 - Character entry buttons (A – Z, 0 – 9) (28, 57)
 - MARK button (28, 57)
 - → and ← buttons (15, 28, 52, 56 – 58)
- 2 TITLE/EDIT button (52 – 56)
- 3 GROUP SKIP >>I button (27, 45 – 50)
- 4 GROUP TITLE/EDIT button (44 – 50, 56)
- 5 GROUP SKIP I<< button (27, 45 – 50)
- 6 LP: button (36)
- 7 PLAY MODE button (21, 22, 25 – 27)
- 8 REPEAT button (22, 27)
- 9 CLOCK/TIMER button (12, 60 – 62)
- 10 SLEEP button (63)
- 11 DIMMER button (12, 15)
- 12 BEEP button (11)
- 13 SOUND button (14)
- 14 AHB PRO (Active Hyper Bass PRO) button (14)
- 15 STANDBY/ON button (11, 61, 62)
- 16 DISP/CHARA (display/character) button (12, 28, 57)
- 17 CANCEL button
- 18 SET button
- 19 ENTER button
- 20 Multi operation buttons
 - ►►I, ■ and I◄◄ buttons
- 21 TITLE SEARCH button (28)
- 22 Recording mode setting buttons
 - GROUP REC button (36)
 - SP/LP2/LP4 button (36)
 - x1,2,4 button (36)
- 23 Source selecting buttons
 - CD ►/|| (play/pause) button (11, 13, 20 – 22)
 - MD ►/|| (play/pause) button (11, 13, 24 – 28)
 - TAPE ◄► (play) button (11, 13, 30)
 - FM/AM/AUX button (11, 13, 17, 18, 32)

Pressing one of these buttons also turns on the unit.
- 24 REV.MODE button (30, 39, 40)
- 25 FM MODE button (17)
- 26 A.P.OFF button (11)
- 27 VOLUME +/- buttons (13)
- 28 COLOR button (9, 15)

Unpacking

After unpacking, check to be sure that you have all the following items.

The number in the parentheses indicates the quantity of the pieces supplied.

- FM antenna (1)
- AM loop antenna (1)
- Remote control (1)
- Batteries (2)

If any is missing, consult your dealer immediately.

Connecting Antennas

FM antenna

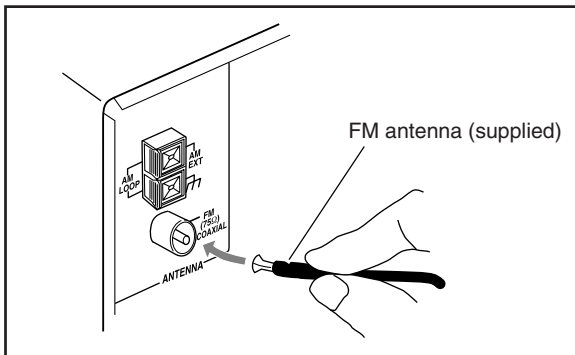

- 1** Attach the FM antenna to the FM (75 Ω) COAXIAL terminal.
- 2** Extend the FM antenna.
- 3** Fasten it up in the position which gives you the best reception.



About the supplied FM antenna

The FM antenna supplied with this unit can be used as temporary measure. If reception is poor, you can connect an outdoor FM antenna.

To connect an outdoor FM antenna

Before connecting it, disconnect the supplied FM antenna.

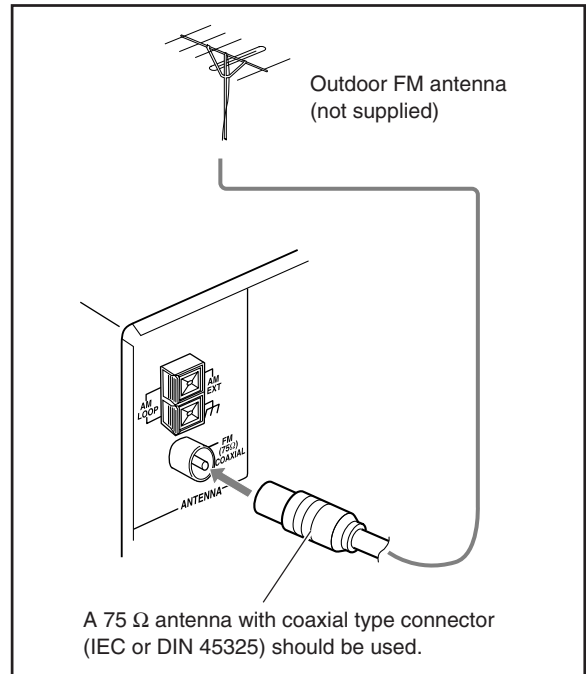

AM antenna

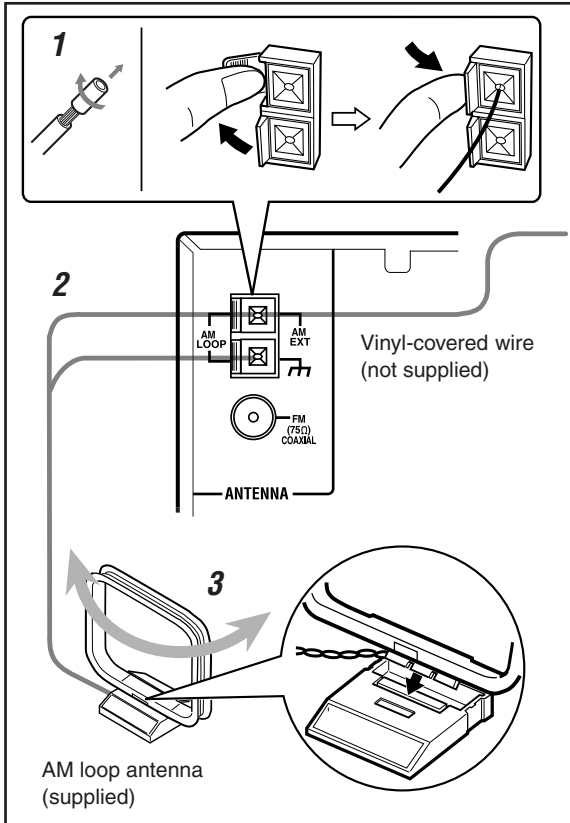

- 1** If cords are covered with insulation, twist the core of the cord at the end of each cord, then remove the insulation.
- 2** Connect the AM loop antenna to the AM LOOP terminals as illustrated.
- 3** Turn the AM loop antenna until you have the best reception.

To connect an outdoor AM antenna

When reception is poor, connect a single vinyl-covered wire to the AM EXT terminal and extend it horizontally. The AM loop antenna must remain connected.



For better reception of both FM and AM

- Make sure the antenna conductors do not touch any other terminals and connecting cords.
- Keep the antennas away from metallic parts of the unit, connecting cords, and the AC power cord.

Connecting Speakers

To connect speakers

You can connect the speakers using the speaker cords.

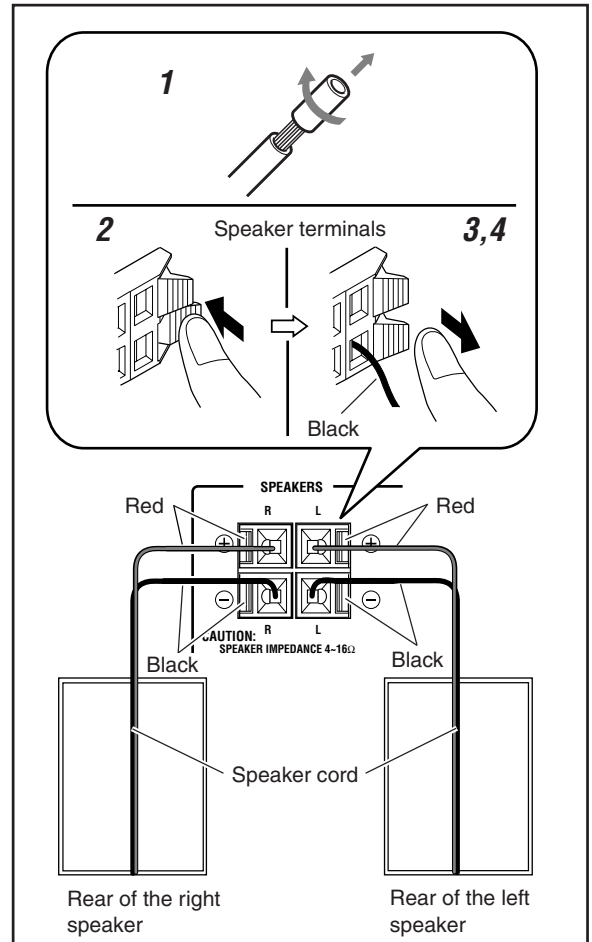

- 1** If cords are covered with insulation, twist the core of the cord at the end of each cord, then remove the insulation.
- 2** Hold the clamp of the speaker terminal.
- 3** Insert the end of the speaker cord to the terminal. Match the polarity of the speaker terminals: Red (+) to red (+) and black (-) to black (-).
- 4** Release the finger from the clamp.

IMPORTANT

- Use only speakers with the same speaker impedance as indicated by the speaker terminals on the rear of the unit.
- DO NOT connect more than one speaker to one speaker terminal.

To remove the speaker grilles

The speaker grilles are removable as illustrated below:

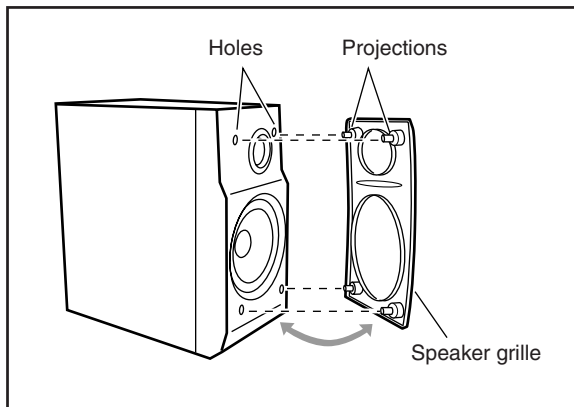

To remove the speaker grille, insert your fingers at the top of the speaker grille, then pull towards you. Also pull the bottom towards you.

To attach the speaker grille, put the projections of the speaker grille into the holes of the speaker.

Caution on installation

This unit is compact but high powered, so it has a built-in cooling fan which operates when the internal heat rises due to continuous use and/or high volume level. If you want to place speakers or any equipment on the sides of the unit, leave a space of at least 1 cm between the main unit and each of them to obtain sufficient cooling effect.

Connecting External Equipment

You can connect another equipment which can be used as a playback device.

When you connect and use the equipment, refer also to its manual supplied.



- DO NOT connect other equipment while the power is on.
- DO NOT plug in any equipment until all connections are complete.

To connect external equipment

Be sure that the plugs of the audio cords and the jacks on the rear of the unit are color-coded: White plugs and jacks are for left audio signals, and red ones for right audio signals.

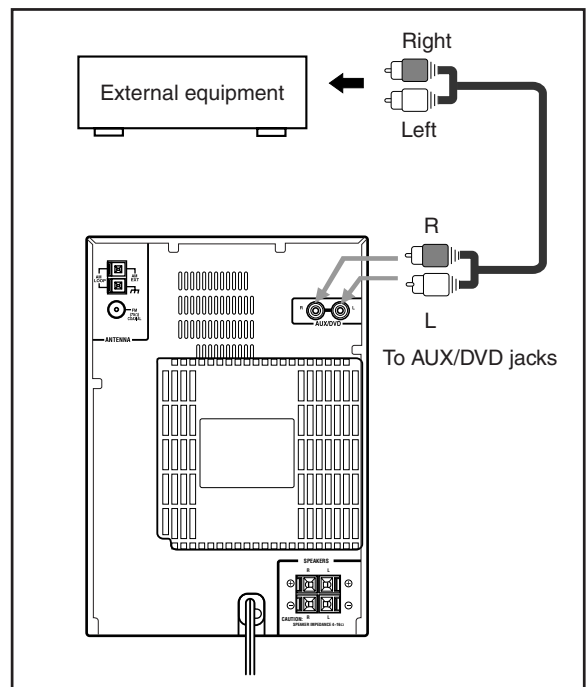

NOW, you can plug in the unit and other connected equipment FINALLY!

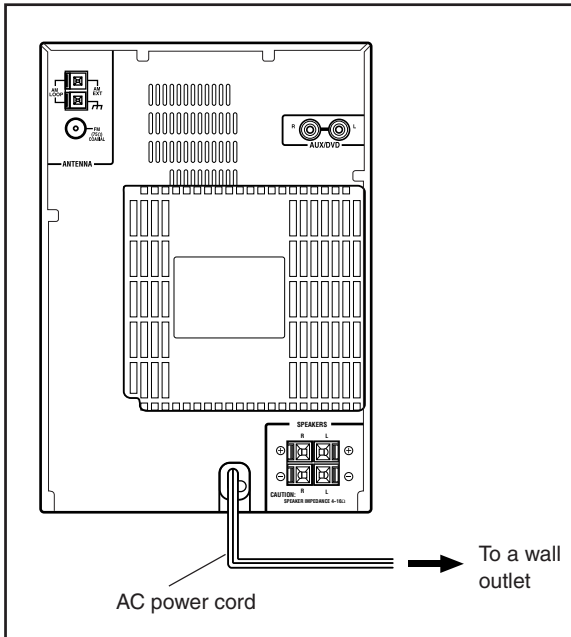

When you connect the AC power cord into a wall outlet, the unit automatically starts display demonstration (Automatic display demonstration).

- Each time you press and hold COLOR/DEMO (or COLOR on the remote control) for more than 2 seconds, Automatic display demonstration turns on and off alternately.

To stop and cancel the display demonstration, press COLOR/DEMO (or COLOR on the remote control) during display demonstration while the unit is in standby mode.

- Pressing DIMMER or DISP/CHARA on the remote control also cancels the display demonstration.
 - When you press DIMMER while the unit is in standby mode, the unit lets you know the time with tones (see page 12).
 - Each time you press DISP/CHARA while the unit is in standby mode, the clock indication turns on and off alternately (see page 12).

To start the display demonstration manually, press COLOR/DEMO (or COLOR on the remote control) while the unit is in standby mode.

- Each time you press the button, the display demonstration alternates between on and off.

Putting the Batteries into the Remote Control

Insert the batteries—R6P(SUM-3)/AA(15F)—into the remote control, by matching the polarity (+ and –) on the batteries with the + and – marking on the battery compartment.

When the remote control can no longer operate the unit, replace both batteries at the same time.

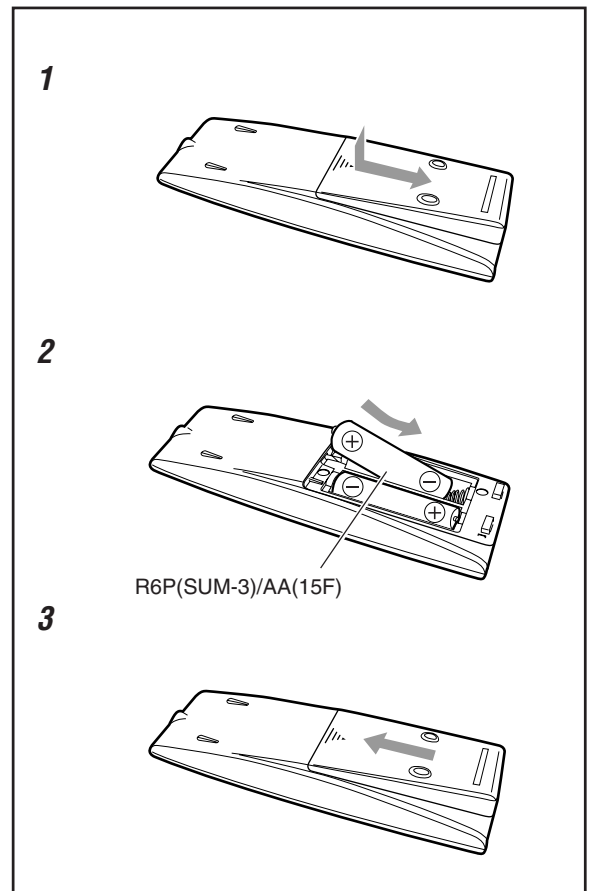

- DO NOT use an old battery together with a new one.
- DO NOT use different types of batteries together.
- DO NOT expose batteries to heat or flame.
- DO NOT leave the batteries in the battery compartment when you are not going to use the remote control for an extended period of time. Otherwise, it will be damaged from battery leakage.

Basic and Common Operations

The buttons emphasized in the illustration below are used and explained in this section (pages 11 to 15).

Remote control

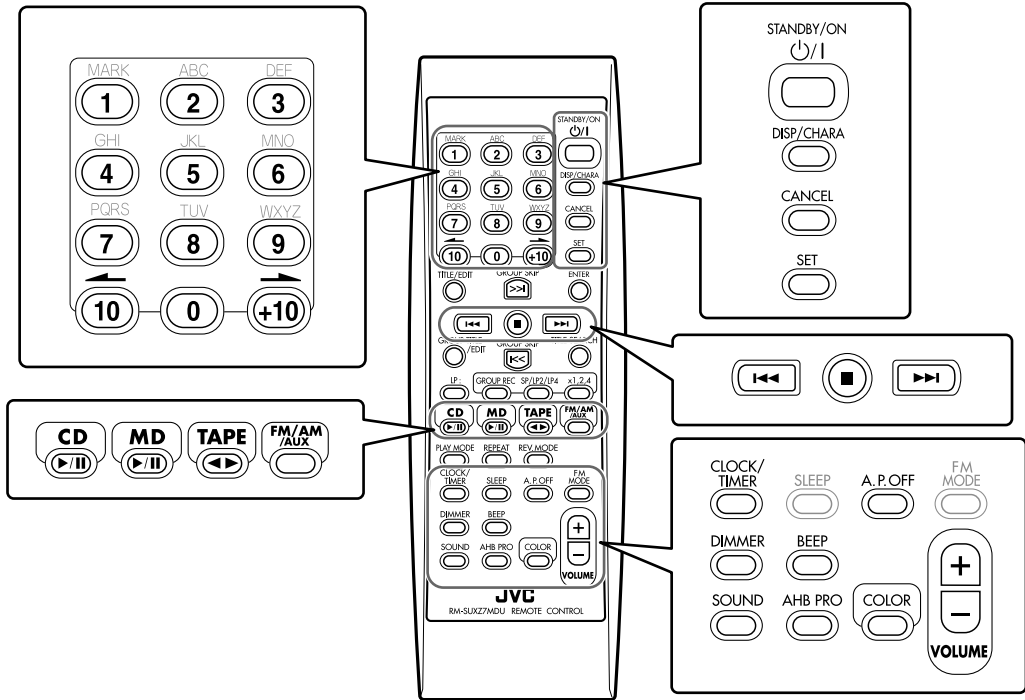

Main unit

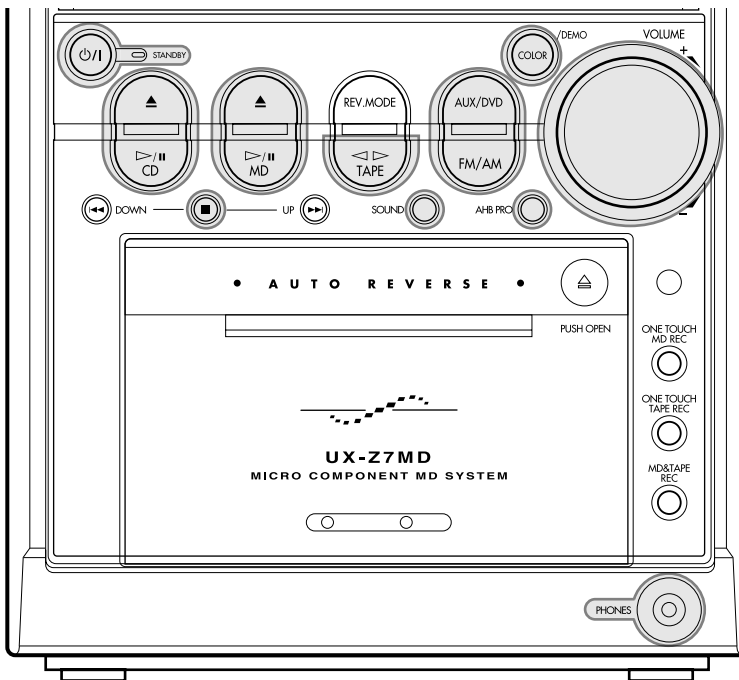

Turning On the Power

When you press one of the source selecting buttons, the unit automatically turns on (and starts playback if the source is ready).

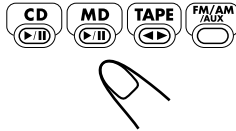

On the remote control:



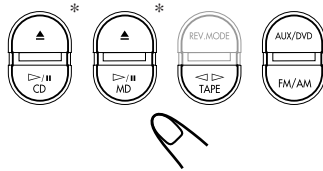

On the main unit



* Pressing CD ▲ or MD ▲ also turns on the unit.

To turn on the unit without playing, press STANDBY/ON  (or  on the main unit). The STANDBY lamp on the main unit goes off. “HELLO” appears in the main display.

To turn off the unit (on standby), press STANDBY/ON  (or  on the main unit) again. The STANDBY lamp on the main unit lights up. “SEE YOU” appears in the main display.

- “0:00” flashes in the main display until you set the built-in clock. After setting the clock, the clock time will appear in the main display while the unit is turned off. To set the built-in clock, see “Setting the Clock” on page 12.
- A little power is always consumed even while the unit is in standby mode.

To switch off the power supply completely, unplug the AC power cord from the AC outlet.



When you unplug the AC power cord or if a power failure occurs

The clock setting and other settings will be erased.

Setting the Auto Power Off

Using Auto Power Off function, the unit automatically turns itself off if no sound comes in for more than 3 minutes except when FM or AM is selected as the source. If any operation is done during this 3-minute period, Auto Power Off is canceled temporarily even though no sound comes in.

On the remote control ONLY:

To activate Auto Power Off, press A.P.OFF.

The A.P.off (Auto Power off) indicator lights up on the display.

- When no sound comes in, the A.P.off indicator starts flashing on the display. About 20 seconds before the unit turns itself off, “AUTO POWER OFF” starts flashing in the main display.

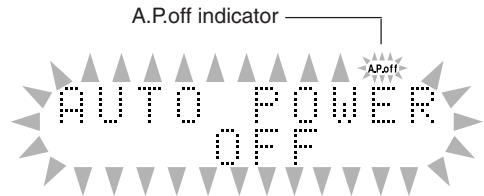

To deactivate Auto Power Off, press A.P.OFF again. The A.P.off indicator goes off from the display.

Turning On/Off the Key-touch Tone

If you do not want the key-touch tone to beep each time you press buttons, you can deactivate it while the unit is turned on.

On the remote control ONLY:

Press BEEP.

- Each time you press the button, the key-touch tone turns on (BEEP ON) and off (BEEP OFF) alternately:

BEEP ON*  BEEP OFF

- * The key-touch tone is activated regardless of the volume setting and headphones connection.

Setting the Clock

You can set the clock whether the unit is turned on or in standby mode.

On the remote control ONLY:

1 Press CLOCK/TIMER.

“0:00” appears in the main display with the hour digit flashing.

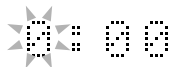

2 Press ►► or ◀◀ repeatedly to adjust the hour.

- When you press and hold the button, the hour digit changes continuously.
- You can also use the number buttons.
 - To adjust the hour to 5, press 5.
 - To adjust the hour to 12, press +10, then 2.
 - To adjust the hour to 20, press +10, then 10 (or press +10 twice, then 0).

3 Press SET to set the hour.

The minute digit starts flashing.

- If you want to correct the hour again, press CANCEL.

The hour digit starts flashing again.

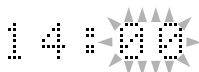

4 Press ►► or ◀◀ repeatedly to adjust the minute.

- When you press and hold the button, the minute digit changes continuously.
- You can also use the number buttons.
 - To adjust the minute to 5, press 5.
 - To adjust the minute to 25, press +10, +10, then 5.
 - To adjust the minute to 30, press +10, +10, then 10 (or press +10 three times, then 0).

5 Press SET to finish setting the clock.

The built-in clock starts.



To adjust the clock again

Once you have adjusted the clock, you need to press CLOCK/TIMER repeatedly until the clock setting screen appears in the main display (the hour digit starts flashing).



When you unplug the AC power cord or if a power failure occurs

The clock loses the setting and is reset to “0:00.” If this happens, set the clock again.

To turn off the clock indication (power save mode)

Press DISP/CHARA while the unit is in standby mode.

“DISPLAY OFF” appears in the main display.

The clock indication goes off from the main display.

To turn on the clock indication, press DISP/CHARA again while the unit is in standby mode.

“DISPLAY ON” appears in the main display.

To check the clock time with tones

When the key-touch tone is activated (see “Turning On/Off the Key-touch Tone” on page 11), the unit lets you know the time using long and short tones in different pitches while the unit is in standby mode.

On the remote control ONLY:

Press DIMMER while the unit is in standby mode.

The time is represented as a four-digit number: two digits each for hours and minutes (ex. 2:58 → 0258). Each digit is distinguished by a different pitch of tone, and numbers are made up of long and short tones.

The following shows the details.

Differentiation of digits:

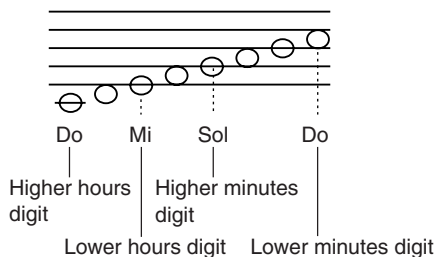

Representation of numbers:

Numbers	0	1	2	3	4
Tones	—	-	--	---	----
Numbers	5	6	7	8	9
Tones*****

*: Five quick short tones

Ex.:

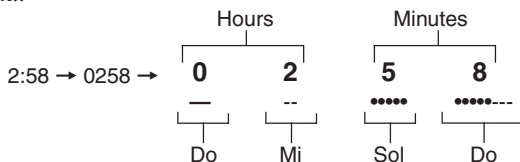

Selecting the Sources and Starting Play

To select the tuner or external equipment as the source
On the remote control:

Press FM/AM/AUX.

The unit automatically turns on (when the unit is in standby), and the last selected source appears in the main display.

- Each time you press the button, the source changes as follows:

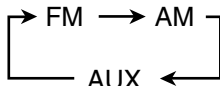

On the main unit:

- Press FM/AM to select the tuner.
 - Each time you press the button, the band alternates between FM and AM.
- Press AUX/DVD to select the external equipment.

- For more detailed tuner operations, see pages 16 to 18.
- For operating the external equipment, see pages 31 and 32 and the manuals supplied with it.

To select the CD player as the source, press CD ►/II.

The unit automatically turns on (when the unit is in standby), and “CD READING” appears in the main display for a while.

- Play will start if a CD is on the disc tray.
- “CD NO DISC” will appear in the main display if a CD is not loaded.

To stop playback, press ■.

- For more detailed operations, see pages 19 to 22.

To select the MD player as the source, press MD ►/II.

The unit automatically turns on (when the unit is in standby), and “MD READING” appears in the main display for a while.

- Play will start if an MD is in the MD loading slot.
- “MD NO DISC” will appear in the main display if an MD is not loaded.

To stop playback, press ■.

- For more detailed operations, see pages 23 to 28.

To select the tape as the source, press TAPE ◀▶.

The unit automatically turns on (when the unit is in standby), and “TAPE” appears in the main display.

- Play will start if a tape is in the cassette holder.

To stop playback, press ■.

- For more detailed operations, see pages 29 and 30.

Adjusting the Volume

You can adjust the volume level only while the unit is turned on.

- The volume level has no effect on recording.

On the remote control:

To increase the volume, press VOLUME + .

To decrease the volume, press VOLUME – .

- When you press and hold each button, you can change the volume level continuously.

On the main unit:

To increase the volume, turn VOLUME + / – control clockwise.

To decrease the volume, turn VOLUME + / – control counterclockwise.

VOLUME 21

- You can adjust the volume level within the range of 0 (silent) to 40 (maximum).



If “CANNOT LISTEN” appears in the main display
During high-speed recording (see page 35), you cannot listen to any source, and therefore, cannot adjust the volume level.



For private listening
Connect a pair of headphones to the PHONES jack. No sound comes out of the speakers. Be sure to turn down the volume before connecting or putting on the headphones.



DO NOT turn off (on standby) the unit with the volume set to an extremely high level; Otherwise, the sudden blast of sound can damage your hearing, speakers and/or headphones when you turn on the unit or start playing any source.
REMEMBER you cannot adjust the volume level while the unit is in standby mode.

Reinforcing the Bass Sound

The richness and fullness of the bass sound is clearly maintained regardless of how low you set the volume —Active Hyper Bass Pro.

- This effect does not affect recording. You can use this effect only for playback.
- This function also effects the sound from headphones.

To get the effect, press AHB PRO repeatedly so that “AHB BASS1” or “AHB BASS2” appears in the main display. The AHBPRO indicator also lights up on the display.

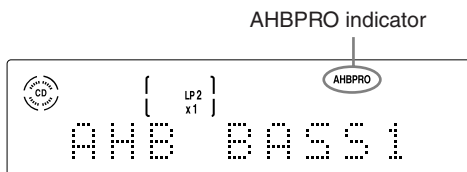

- Each time you press the button, the Active Hyper Bass Pro mode changes as follows:

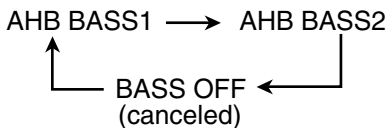

- “AHB BASS2” is more effective than “AHB BASS1.”

To cancel the effect, press AHB PRO repeatedly until “BASS OFF” appears in the main display. The AHBPRO indicator goes off from the display.

Selecting the Sound Modes

You can select one of the 4 preset sound modes.

- This effect does not affect recording. You can use this effect only for playback.
- This function also effects the sound from headphones.

To select the sound modes, press SOUND repeatedly until the sound mode you want appears in the main display. The SOUND indicator also lights up on the display.

- Each time you press the button, the sound mode changes as follows:

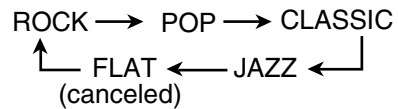

- ROCK:** Boosts low and high frequency. Good for acoustic music.
- POP:** Good for vocal music or voice.
- CLASSIC:** Good for classical music.
- JAZZ:** Good for jazz music.
- FLAT:** Cancels the sound mode.

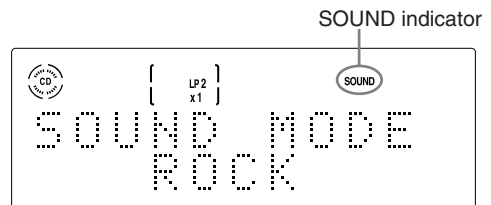

Ex.: When you select “ROCK.”

To check the sound mode currently selected, press SOUND.

The currently selected sound mode will appear in the main display.

To cancel the sound modes, press SOUND repeatedly until “FLAT” appears in the main display. The SOUND indicator goes off from the display.

Setting the Display Illumination

You can change the illumination color and brightness of the electronic swing panel and the display window.

To select the illumination color

You can select the illumination color by your preference.

Press **COLOR** (or **COLOR/DEMO** on the main unit) repeatedly while the unit is turned on until the color you want appears in the main display.

- Each time you press the button, the illumination color changes as follows:

RAINBOW:	The rainbow colors illuminate the electronic swing panel and the display.
↓	
GRADATION:	The illumination color changes gradually.
↓	
WATER:	A blue-based illumination pattern.
↓	
FANTASY:	Pastel colors illuminate the electronic swing panel and the display.
↓	
CANDLE:	A red-based illumination pattern.
↓	
FOREST:	A green-based illumination pattern.
↓	
SNOW:	A white-based illumination pattern.
↓	
SKY:	A sky-color based illumination pattern. The color changes when particular times come if the built-in clock is set. If not, "ADJUST CLOCK!" flashes in the main display.
↓	
MANUAL1:	You can set the illumination color as you like (see the right column).
↓	
MANUAL2:	
↓	
	(back to the beginning)



More on the illumination color

- The illumination colors cannot always be reproduced precisely. Due to the circumstances (room temperature, etc.) where the unit is used or the setting of DIMMER, colors may vary slightly.
- When you change the illumination color, the display may seem to move back and forth; this is a characteristic of this unit and is not a malfunction.
- When a strong light strikes the unit, it may become dark, but this is not a malfunction.
- While using the unit, the electronic swing panel becomes warm, but this is not a malfunction.

To create your favorite colors

You can create two favorite colors and store them in memory as "MANUAL1" and "MANUAL2."

- There is a time limit in doing the following steps. If the unit exits from the color adjusting mode before you finish, start from step 1 again.

On the remote control ONLY:

- 1 Press **COLOR** repeatedly until "MANUAL1" or "MANUAL2" appears in the main display.
The brightness level to be adjusted starts flashing.

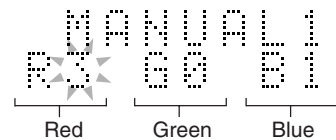

- 2 To adjust the brightness of each color
 - 1) Press **→** or **←** to select the color you want to adjust.
 - 2) Press **▶▶** or **◀◀** repeatedly to adjust the level of the brightness (within the range of 0 to 3).
 - As you increase the number, the color becomes brighter.
 - 3) Repeat steps 1) and 2) to find your favorite color.



When you unplug the AC power cord or if a power failure occurs

The color settings you have made will be erased. If this happens, the illumination color resumes "RAINBOW" but the colors you have made for "MANUAL1" and "MANUAL2" will remain.

To change the display brightness

On the remote control ONLY:

Press **DIMMER** while the unit is turned on.

- Each time you press the button, the display brightness changes as follows:

DIMMER1: The display illumination dims.



DIMMER2: The display illumination disappears.



DIMMER OFF: The display illumination resumes.

- Pressing **COLOR** (or **COLOR/DEMO** on the main unit) also resumes the display brightness.



(back to the beginning)

Listening to FM and AM Broadcasts

The buttons emphasized in the illustration below are used and explained in this section (pages 17 and 18).

Remote control

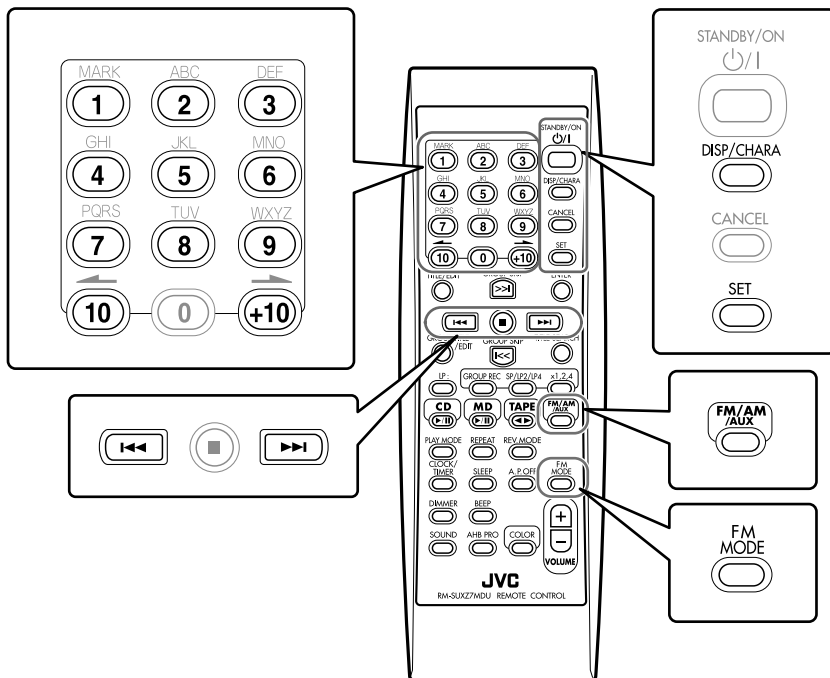

Main unit

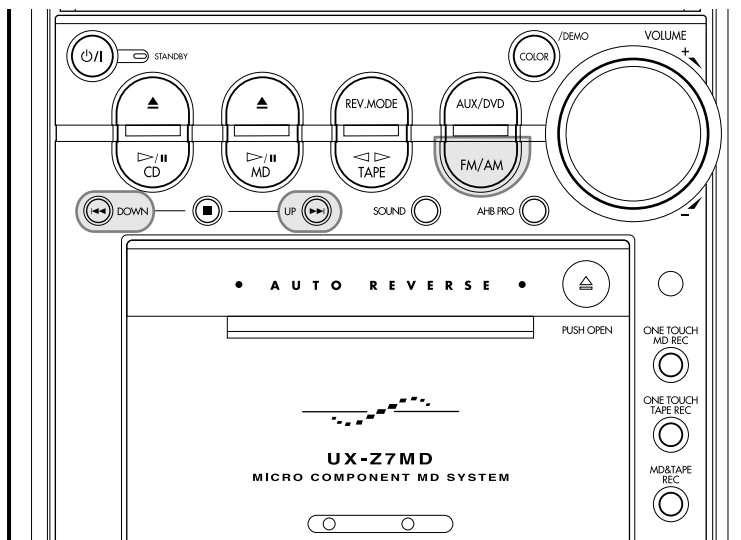

Tuning in to a Station

- 1** Press FM/AM/AUX (or FM/AM on the main unit) to select either “FM” or “AM.”

When you press the button for the first time, the unit automatically turns on with the last selected source.

On the remote control:

- Each time you press the button, the source changes as follows:



On the main unit:

- Each time you press the button, the band alternates between FM and AM.

- 2** Press and hold ►► or ◀◀ (UP or DOWN on the main unit) until the station frequencies start changing continuously in the main display.

- ►► (UP): Increases the frequencies.
- ◀◀ (DOWN): Decreases the frequencies.

The unit starts searching for stations and stops when a station of sufficient signal strength is tuned in.

- If an FM program is broadcast in stereo, the STEREO indicator lights up on the display.

To stop during searching, press ►► or ◀◀ (or UP or DOWN on the main unit).



When you repeatedly press ►► or ◀◀ (or UP or DOWN on the main unit)

The frequency changes step by step.

To change the FM reception mode

When an FM stereo broadcast is noisy or hard to receive, you can change the FM reception mode to improve the reception.

On the remote control ONLY:

Press FM MODE.

- Each time you press the button, FM reception mode alternates between STEREO and MONO.

STEREO: Normally select this.

You can hear stereo sound when a program is broadcast in stereo. The STEREO indicator lights while receiving the FM stereo broadcast (only when the reception is good).

MONO: Select this when an FM stereo broadcast is noisy or hard to receive. Reception improves though stereo effect is lost. The MONO indicator lights up on the display.

To change the information shown in the main display

On the remote control ONLY:

Each time you press DISP/CHARA, the information in the main display alternates between the source indication and the clock indication.

- If an MD is inserted, the MD remaining recording time (“REC REMAIN”) is shown before the clock indication.

Presetting Stations

You can preset 30 FM and 15 AM stations manually.

In some cases, test frequencies have been already memorized for the tuner since the factory examined the tuner preset function before shipment. This is not a malfunction. You can preset the stations you want into memory by following the presetting method.

- There is a time limit in doing the following steps. If the setting is canceled before you finish, start from step **2** again.

On the remote control ONLY:

1 Tune in to the station (either FM or AM) you want to preset.

- See “Tuning in to a Station” on the previous page.

2 Press SET.

The preset number starts flashing as follows:

FM 1
87.50MHz

Ex.: When you select an FM station in step **1**.

- The unit always starts from the preset number 1.

3 Press the number buttons to select a preset number.

Ex.: For preset number 5, press 5.

For preset number 15, press +10, then 5.

For preset number 20, press +10, then 10.

For preset number 30, press +10, +10, then 10.

- You can also select the preset number by pressing ►► or ◀◀.

4 Press SET again.

“STORED” appears in the main display for a while.

STORED

The tuned station in step **1** is stored in the preset number selected in step **3**.

- Storing a new station on a used number erases the previously stored one.



When you unplug the AC power cord or if a power failure occurs

The FM and AM preset stations will be erased in a day. If this happens, preset the stations again.

Tuning in to a Preset Station

On the remote control ONLY:

1 Press FM/AM/AUX to select either “FM” or “AM.”

When you press the button for the first time, the unit automatically turns on with the last selected source.

- Each time you press the button, the source changes as follows:



2 Press the number buttons to select a preset number.

Ex.: For preset number 5, press 5.

For preset number 15, press +10, then 5.

For preset number 20, press +10, then 10.

For preset number 30, press +10, +10, then 10.

Playing Back CDs (CD-R/CD-RW)

The buttons emphasized in the illustration below are used and explained in this section (pages 20 to 22).

Remote control

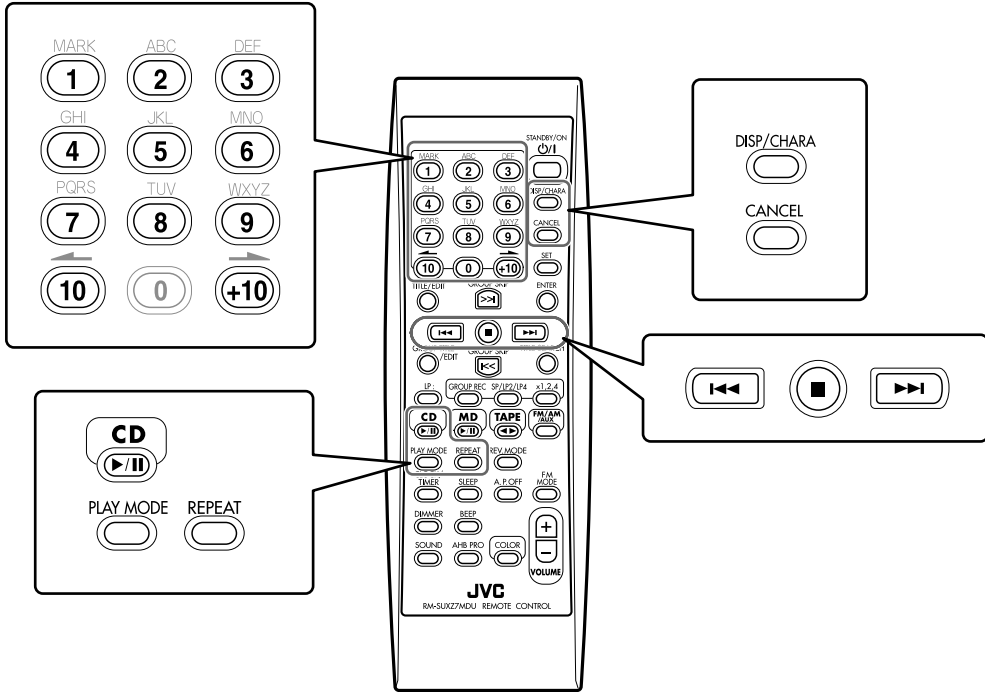

Main unit

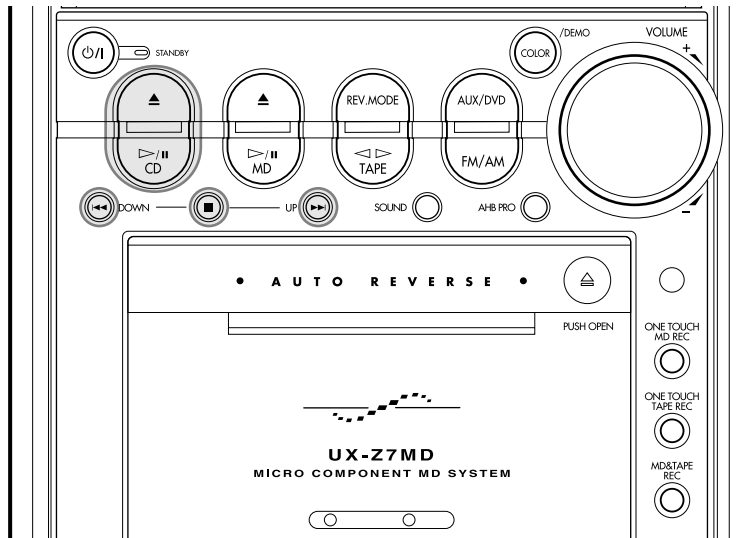

Precautions on CD Playback

This unit has been designed to play back discs bearing the following logos:



Audio CD



CD Recordable (CD-R)



CD ReWritable (CD-RW)

In addition to the above discs, this unit can play back audio data recorded on CD Text, CD-G (CD Graphics), and CD-Extra.

When playing a CD-R or CD-RW

User-edited CD-Rs (CD-Recordable) and CD-RWs (CD-ReWritable) can be played back when they are already “finalized.” If you try to play back **unfinalized** discs, “CD NO DISC” may appear in the main display.

- You can play back your original CD-Rs or CD-RWs recorded in **audio CD format ONLY**. (If CD-RWs have been recorded in different format, erase all the data on CD-RWs completely before re-recording on the discs.)



DO NOT play back CD-Rs or CD-RWs recorded with sound files such as MP3.

- Before playing back CD-Rs or CD-RWs, read their instructions or cautions carefully.
- Some CD-Rs or CD-RWs may not be played back on this unit because of their disc characteristics, damage or stain on them, or if the player’s lens is dirty.

Important notices:

- In general, you will have the best performance by keeping your discs and the mechanism clean.
 - Store discs in their cases, and keep them in cabinets or on shelves.
 - Keep the unit’s disc tray closed when not in use.
- Continuous use of irregular shaped discs (heart-shape, octagonal, etc.) can damage the disc rotating mechanism.



- CD-RWs may require a longer readout time since the reflectance of CD-RWs is lower than for regular CDs.

Playing Back the Entire CD—Normal Play

1 Press CD ▲ on the main unit.

The unit automatically turns on, the electronic swing panel slides downward, then the disc tray comes out.

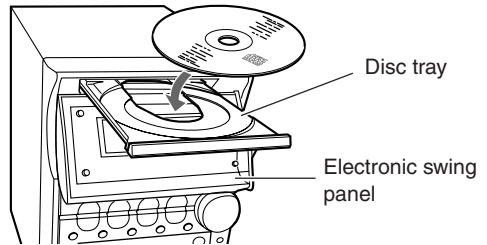

2 Place a disc correctly on the circle of the disc tray with its label side up.

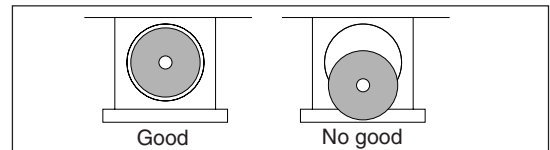

- When using a CD single (8 cm), place it on the inner circle of the disc tray.

3 Press CD ►/||.

The disc tray closes, then the electronic swing panel slides upward automatically.

The CD indicator starts flashing on the display and disc playback starts from the first track of the disc.

- If you press CD ▲ instead of CD ►/||, the disc tray and electronic swing panel close, but disc playback does not start.

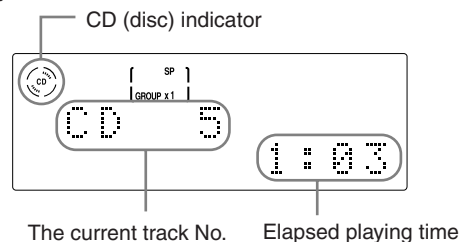

Disc playback stops after playing all the tracks of the disc.

To stop during play, press ■.

To remove the disc, press CD ▲.

- After removing the disc, press CD ▲ again to close the disc tray.

Basic CD Operations

While playing a disc, you can do the following operations.

To stop playback for a moment

Press **CD ►/||**.

The CD indicator and the elapsed playing time start flashing on the display.

- When the key-touch tone is activated (see page 11), the unit keeps beeping while pausing.

To resume playback, press **CD ►/||** again.

To locate a particular point in a track during play

Press and hold **►►** or **◄◄**.

- **►►**: Fast-forwards the track.
- **◄◄**: Fast-reverses the track.

To go to another track

Press **►►** or **◄◄** repeatedly.

- **►►**: Skips to the beginning of the next or succeeding tracks.
- **◄◄**: Goes back to the beginning of the current or previous tracks.

To go to another track directly using the number buttons

On the remote control ONLY:

Pressing the number button(s) allows you to start playing the track number you want.

- Ex.: For track number 5, press 5.
 For track number 15, press +10, then 5.
 For track number 20, press +10, then 10.
 For track number 32, press +10, +10, +10, then 2.

To change the information shown in the main display

On the remote control ONLY:

Each time you press **DISP/CHARA**, the information in the main display alternates between the source indication and the clock indication.

- If an MD is inserted, the MD remaining recording time (“REC REMAIN”) is shown before the clock indication.

About CD indicator



A disc is loaded



During playback



During pause

Programing the Playing Order of the Tracks —Program Play

You can arrange the order in which the tracks play before you start playing. You can program up to 32 tracks.

On the remote control ONLY:

- 1 Load a disc.
- 2 Press **CD ►/||**, then **■**.
The source is changed to “CD.”
- 3 Press **PLAY MODE** repeatedly so that “**CD PROGRAM**” appears in the main display.
The PRGM (program) indicator lights up on the display.
 - Each time you press the button, play mode changes as follows:

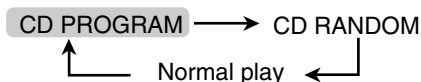

- 4 Press the number buttons to select the tracks.

- For how to use the number buttons, see “To go to another track directly using the number buttons” in the left column.

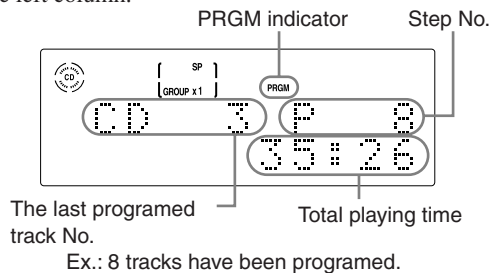

- 5 Press **CD ►/||**.

The tracks are played in the order you have programmed. Program play ends when all the programmed tracks are played once (when Repeat play is not activated).

To stop during play, press **■**.

The last programmed track number and total playing time appear in the main display.

To exit from Program play mode, press **PLAY MODE** once or twice so that the unit enters another playback mode (Random play or Normal play mode) before or after play.

To check the program contents

Before playing, you can check the program contents by pressing ►►| or |◄◄.

- ►►|: Shows the programmed tracks in the programmed order.
- |◄◄: Shows them in the reverse order.

To modify the program

Before playing, you can erase the last programmed track by pressing CANCEL on the remote control. Each time you press the button, the last programmed track is erased from the program.

To add tracks in the program before you start play, simply select track numbers you want to add.

To erase the entire program, press CD ▲ to eject the disc.

- Turning off the unit will also erase the program.



If your entry is ignored

You have tried to program a track number that does not exist on the disc (for example, selecting track 14 on a disc that only has 12 tracks). Such entries are ignored.



If you try to program a 33rd step

“MEMORY FULL” will appear in the main display.



If the total playing time is 100 minutes or more

The total playing time will not be shown. (“-- : --” will appear.)

Playing at Random—Random Play

The tracks of a loaded disc will play at random.

On the remote control ONLY:

1 Load a disc.

2 Press CD ►/II, then ■.

The source is changed to “CD.”

3 Press PLAY MODE repeatedly so that “CD RANDOM” appears in the main display.

The RANDOM indicator lights up on the display.

- Each time you press the button, play mode changes as follows:

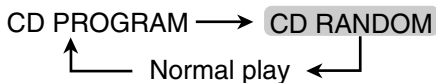

4 Press CD ►/II.

The tracks are played at random.

Random play ends when all the tracks are played once.

To skip the current track, press ►►|.

- You cannot go back to the previous tracks by pressing |◄◄.

To stop during playback, press ■.

To exit from Random play mode, press PLAY MODE once or twice so that the unit enters another playback mode (Normal play or Program play mode) before or after play.

Repeating Tracks—Repeat Play

You can have all the tracks, the program or the individual track currently playing repeat as many times as you like.

On the remote control ONLY:

To repeat play, press REPEAT during or before play.

- Each time you press the button, Repeat play mode changes as follows:

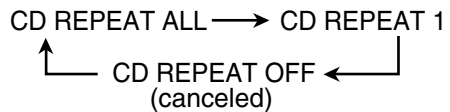

“CD REPEAT ALL”:

Repeats all the tracks on the disc (in Normal play or Random play mode), or all the tracks in the program.

The **ALL** indicator lights up on the display.

“CD REPEAT 1”:

Repeats one track.

The **1** indicator lights up on the display.

“CD REPEAT OFF”:

Cancels the repeat play.

- Ejecting the disc or turning off the unit will also cancel the repeat play.

To stop during play, press ■.

To prohibit disc ejection—Disc Lock

You can prohibit disc and MD ejection from the unit, and can lock the discs.

See “To prohibit disc ejection—Disc Lock” on page 25 for details.

Playing Back MDs

The buttons emphasized in the illustration below are used and explained in this section (pages 24 to 28).

Remote control

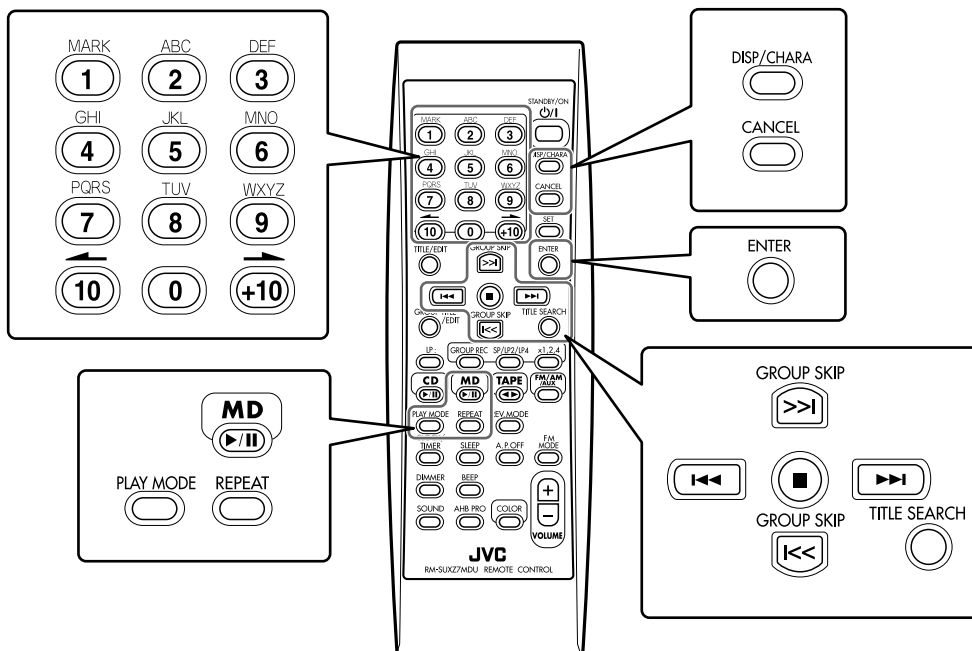

Main unit

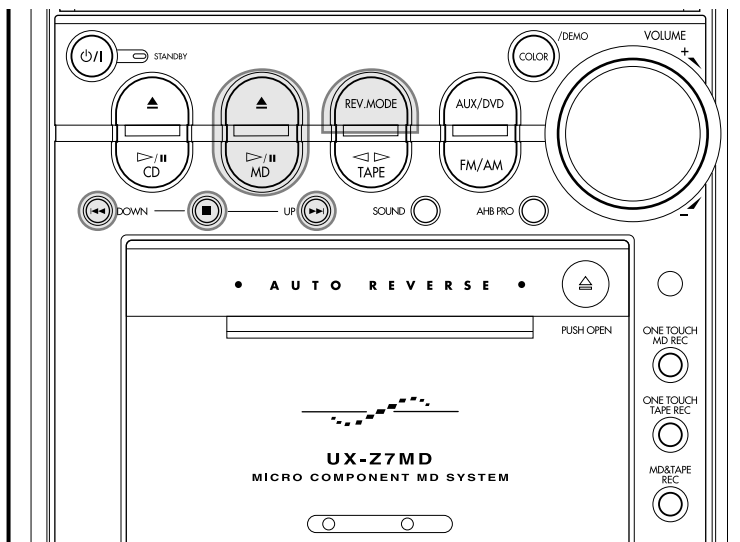

Playing Back the Entire MD—Normal Play

1 Press MD ▲ on the main unit.

The unit automatically turns on, the electronic swing panel slides upward, then the MD loading slot appears.

- If an MD is already in the MD loading slot, it will be ejected.

2 Insert an MD into the MD loading slot.

The MD is pulled in, then the electronic swing panel slides downward automatically.

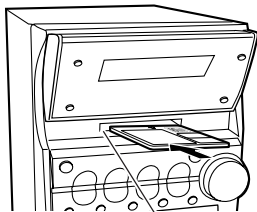

Insert an MD in the same way as indicated on the MD.

MD loading slot

- When the current source is MD, the information on the loaded MD appears in the main display as follows:

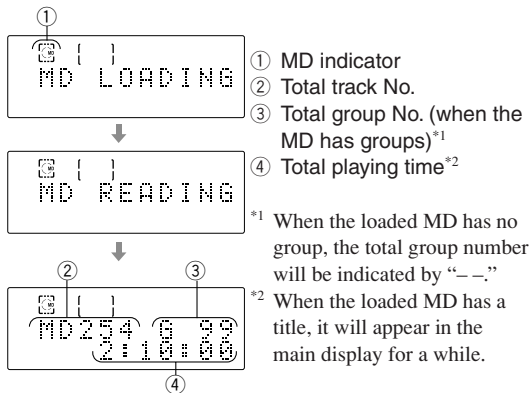

3 Press MD ►/II.

The MD indicator starts flashing on the display and MD playback starts from the first track.

The recording length mode (SP/LP2/LP4) appears in the main display. (About the recording length mode, see the right column.)

MD playback stops automatically after playing all the tracks on the MD.

To stop during play, press ■.

To remove the disc, press MD ▲.

- After removing the disc, press MD ▲ again to close the electronic swing panel.



While the unit is pulling in the MD:

- DO NOT press MD ▲.
- DO NOT close the electronic swing panel by force.



If the MD or track has a title

The title will appear in the main display for a while. (If a title is long and cannot be shown at a time, the unit scrolls the title to show the entire title.)



About recording length mode

MDs are played back in the same recording length mode as they were recorded. When an MD starts playing, the playback mode of the currently playing track appears in the main display.

SP: Indicates the tracks recorded in standard stereo recording mode on this unit or those recorded on an MD recorder incompatible with MDLP (see below).

LP2: Indicates the tracks recorded in 2 times long-hour stereo recording mode.

LP4: Indicates the tracks recorded in 4 times long-hour stereo recording mode.

For more details, see page 35.

MDLP features a new sound compression method (ATRAC3) and a 2 times (or 4 times) long-hour stereo recording and playing function. The MDLP logo is marked on the MD recorders and players compatible with MDLP. It is also marked on MDs pre-recorded in ATRAC3 (excluding recordable MDs).

Basic MD Operations

While playing an MD, you can do the following operations.

To stop playback for a moment

Press MD ►/II.

The MD indicator and the elapsed playing time start flashing on the display.

- When the key-touch tone is activated (see page 11), the unit keeps beeping while pausing.

To resume playback, press MD ►/II again.

To locate a particular point in a track during play

Press and hold ►► or ◀◀.

- ►►: Fast-forwards the track.
- ◀◀: Fast-reverses the track.

To go to another track

Press ►►| or |◄◄ repeatedly.

- ►►|: Skips to the beginning of the next or succeeding tracks.
- |◄◄: Goes back to the beginning of the current or previous tracks.

To go to another track directly using the number buttons

On the remote control ONLY:

Pressing the number button(s) allows you to start playing the track number you want.

- Ex.: For track number 5, press 5.
 For track number 15, press +10, then 5.
 For track number 20, press +10, then 10.
 For track number 32, press +10, +10, +10, then 2.

To change the information shown in the main display

On the remote control ONLY:

Each time you press DISP/CHARA, the information in the main display changes as follows:

While playing or pausing:

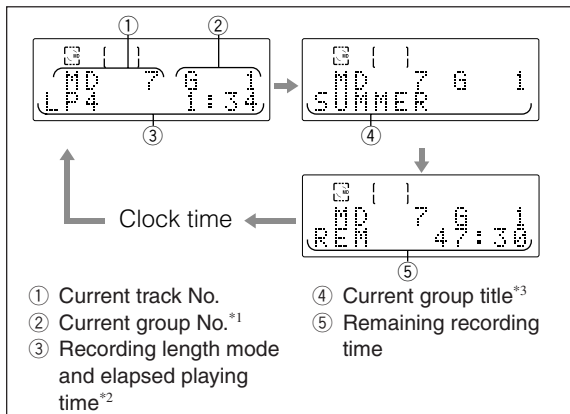

When the MD recorder stops:

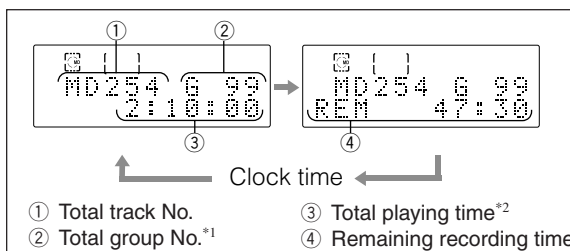

^{*1} When the current track does not belong to any groups or when the disc has no group, “- -” will appear.
^{*2} When the current track or the disc has a title, its title will appear for a while.
^{*3} When the group has no title, “NO TITLE” appears.

About MD indicator



An MD is loaded



During playback



During pause

To prohibit disc ejection—Disc Lock

You can prohibit disc and MD ejection from the unit and can lock discs.

On the main unit ONLY:

To prohibit disc ejection

Press REV.MODE while holding ■ when the unit is in standby mode.

“LOCKED” appears in the main display for a while, and the loaded discs (both disc and MD) are locked.



If you try to eject the locked discs “LOCKED” appears to inform you that the Disc Lock is in use.

To cancel the prohibition and unlock the discs, repeat the above procedure.

“UNLOCKED” appears in the main display for a while, and the loaded discs (both disc and MD) are unlocked.

Programming the Playing Order of the Tracks—Program Play

You can arrange the order in which the tracks play before you start playing. You can program up to 32 tracks.

On the remote control ONLY:

- 1 Load an MD.
- 2 Press MD ►/II, then ■.
The source is changed to “MD.”
- 3 Press PLAY MODE repeatedly so that “MD PROGRAM” appears in the main display.
The PRGM (program) indicator lights up on the display.
 - Each time you press the button, play mode changes as follows:

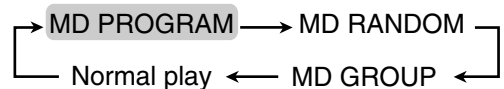

4 Press the number buttons to select the tracks.

- For how to use the number buttons, see “To go to another track directly using the number buttons” on the previous page.

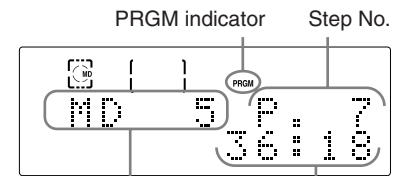

The last programmed track No.
Total playing time
Ex.: 7 tracks have been programmed.

5 Press MD ►/II.

The tracks are played in the order you have programmed. Program play ends when all the programmed tracks are played once (when Repeat play is not activated).

To stop during play, press ■.

The last programmed track number and total playing time appear in the main display.

To exit from Program play mode, press PLAY MODE repeatedly so that the unit enters another playback mode (Random play, Group play or Normal play mode) before or after play.

To check the program contents

Before playing, you can check the program contents by pressing ►►I or I◄◄.

- I: Shows the programmed tracks in the programmed order.
- I◄◄: Shows them in the reverse order.

To modify the program

Before playing, you can erase the last programmed track by pressing CANCEL on the remote control. Each time you press the button, the last programmed track is erased from the program.

To add tracks in the program before you start play, simply select track numbers you want to add.

To erase the entire program, press MD ▲ to eject the MD.

- Turning off the unit will also erase the program.



If your entry is ignored

You have tried to program a track that does not exist on the MD (for example, selecting track 14 on an MD that only has 12 tracks). Such entries are ignored.



If you try to program a 33rd step
“MEMORY FULL” will appear in the main display.



If the total playing time is 150 minutes or more
The total playing time will not be shown. (“-- : --” will appear.)

Playing at Random—Random Play

The tracks of the loaded MD will play at random.

On the remote control ONLY:

- Load an MD.
- Press MD ►/II, then ■.
The source is changed to “MD.”
- Press PLAY MODE repeatedly so that “MD RANDOM” appears in the main display.
The RANDOM indicator lights up on the display.
 - Each time you press the button, play mode changes as follows:

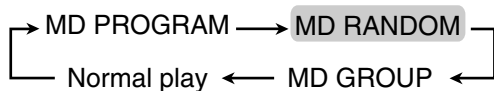

4 Press MD ►/II.

The tracks are played at random.

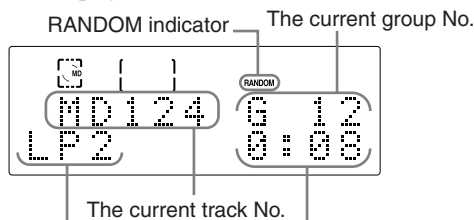

Random play ends when all the tracks are played once.

To skip the playing track, press ►►I.

- You cannot go back to the previous tracks by pressing I◄◄.

To stop during play, press ■.

To exit from Random play mode, press PLAY MODE repeatedly so that the unit enters another playback mode (Group play, Normal play or Program play mode) before or after play.

Playing Tracks in a Group—Group Play

You can play back tracks in a group.

- To make or edit groups, see pages 42 to 50.

On the remote control ONLY:

1 Load an MD including a group(s).

2 Press MD ►/II, then ■.

The source is changed to “MD.”

3 Press PLAY MODE repeatedly so that “MD GROUP” appears in the main display.

The GROUP indicator lights up on the display.

- Each time you press the button, play mode changes as follows:

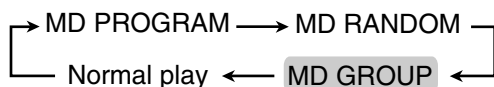

4 Press GROUP SKIP >>I or GROUP SKIP I<< to select a group.

- GROUP SKIP >>I: Selects group numbers in the increasing order.
- GROUP SKIP I<<: Selects group numbers in the decreasing order.

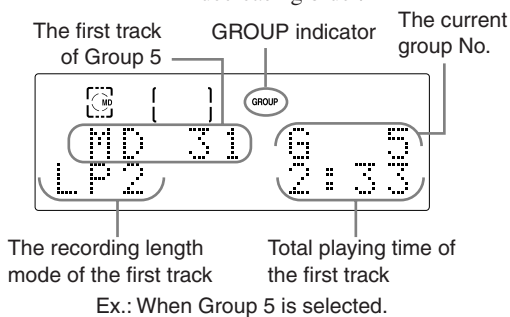

5 Press MD ►/II.

The tracks in the selected group are played.

- When the loaded MD has no groups, all the tracks on the MD are played back the same way as in Normal play.

Group play ends when all the tracks in the selected group are played back.

To go to another track in the same group, press ►►I or I<<< repeatedly.

- ►►I: Skips to the beginning of the next or succeeding tracks.
- I<<<: Goes back to the beginning of the current or previous tracks.

To go to another group, press GROUP SKIP >>I or GROUP SKIP I<< repeatedly during Group play.

- GROUP SKIP >>I: Skips to the first track in the next or succeeding groups.
- GROUP SKIP I<<: Goes back to the first track in the current or previous groups.

To stop during play, press ■.

To exit from Group play mode, press PLAY MODE repeatedly so that the unit enters another playback mode (Normal play, Program play or Random play mode) before or after play.

- Pressing one of number buttons also cancels Group play and starts Normal play from the track selected by the button.

Repeating Tracks—Repeat Play

You can have all the tracks, the program, a group or the individual track currently playing repeat as many times as you like.

On the remote control ONLY:

To repeat play, press REPEAT during or before play.

- Each time you press the button, Repeat play mode changes as follows:

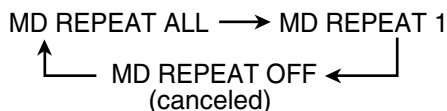

“MD REPEAT ALL”:

- For Normal play or Random play mode: Repeats all the tracks on the MD.

- For Group play mode: Repeats all the tracks in a group.

- For Program play mode: Repeats all the tracks in the program.

The ◀ ALL indicator lights up on the display.

“MD REPEAT 1”:

- Repeats one track.
- The ◀ indicator lights up on the display.

“MD REPEAT OFF”:

- Cancels the repeat play.

- Ejecting the MD or turning off the unit will also cancel the repeat play.

To stop during play, press ■.

Searching for Tracks to Play —MD Title Search

You can search for the tracks by their titles and play them back.

For details on assigning a title, see pages 56 – 58.

On the remote control ONLY:

1 Load an MD.

2 Press MD ►/II, then ■.

The source is changed to “MD.”

3 Press TITLE SEARCH.

The TITLE SEARCH indicator lights up on the display.

The play mode changes to Normal play.

“TITLE” and the character entry position appear in the main display.

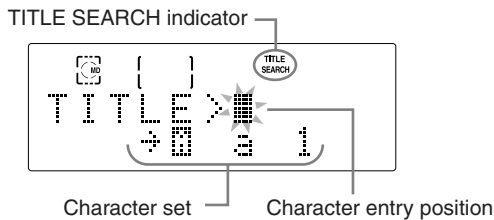

4 Enter the character(s) to search for the track title.

You can enter up to 5 characters. The unit will search for the tracks which have the entered characters at the head of their titles.

- You can also search for the tracks without a title. In this case, go to step 5 without entering any character.

1) Press DISP/CHARA to select the character set you want.

- Each time you press the button, the character set changes as follows:

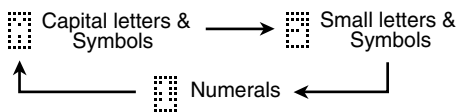

2) Press the character entry button for a character you want to enter.

Ex.:

- To enter an “A” or “a,” press ABC once.
To enter a “B” or “b,” press ABC twice.
To enter a “C” or “c,” press ABC three times.
- To enter a symbol, press MARK repeatedly until the mark you want appears.
- To enter a numeral, press 0 – 9.
- To enter a space while entering a title, press → twice.
- To move the character entry position while entering a title, press → or ←.
- If you have entered an incorrect character, press → or ← to select the character you want to correct, then press CANCEL to delete it.

3) Repeat steps 4 – 1) and 4 – 2) to enter other characters.

- If the character you want to enter next is assigned to the same button you have just pressed in step 4 – 2), press → once to move the character entry position to the right.

5 Press ENTER.

“SEARCH •••” scrolls and the TITLE SEARCH indicator starts flashing on the display. The unit starts searching for the track.

- When the track with the desired title is found, the unit plays back the track. (After the track is played, the unit starts searching for the next matching track.)
- If no track with the desired title is found, “SEARCH END” appears in the main display and Normal play mode resumes (the TITLE SEARCH indicator goes off).

To skip the current playback and search for the next track, press ►►.

To cancel title searching, press TITLE SEARCH.

When you press the button during playback or search, Normal play resumes.



Available symbols are as follows:

(Blank)	!	"	#	\$	%	&	'	()
*	+	,	-	.	/	:	;	< =
>	?	@	_	\				

Playing Back Tapes

The buttons emphasized in the illustration below are used and explained in this section (page 30).

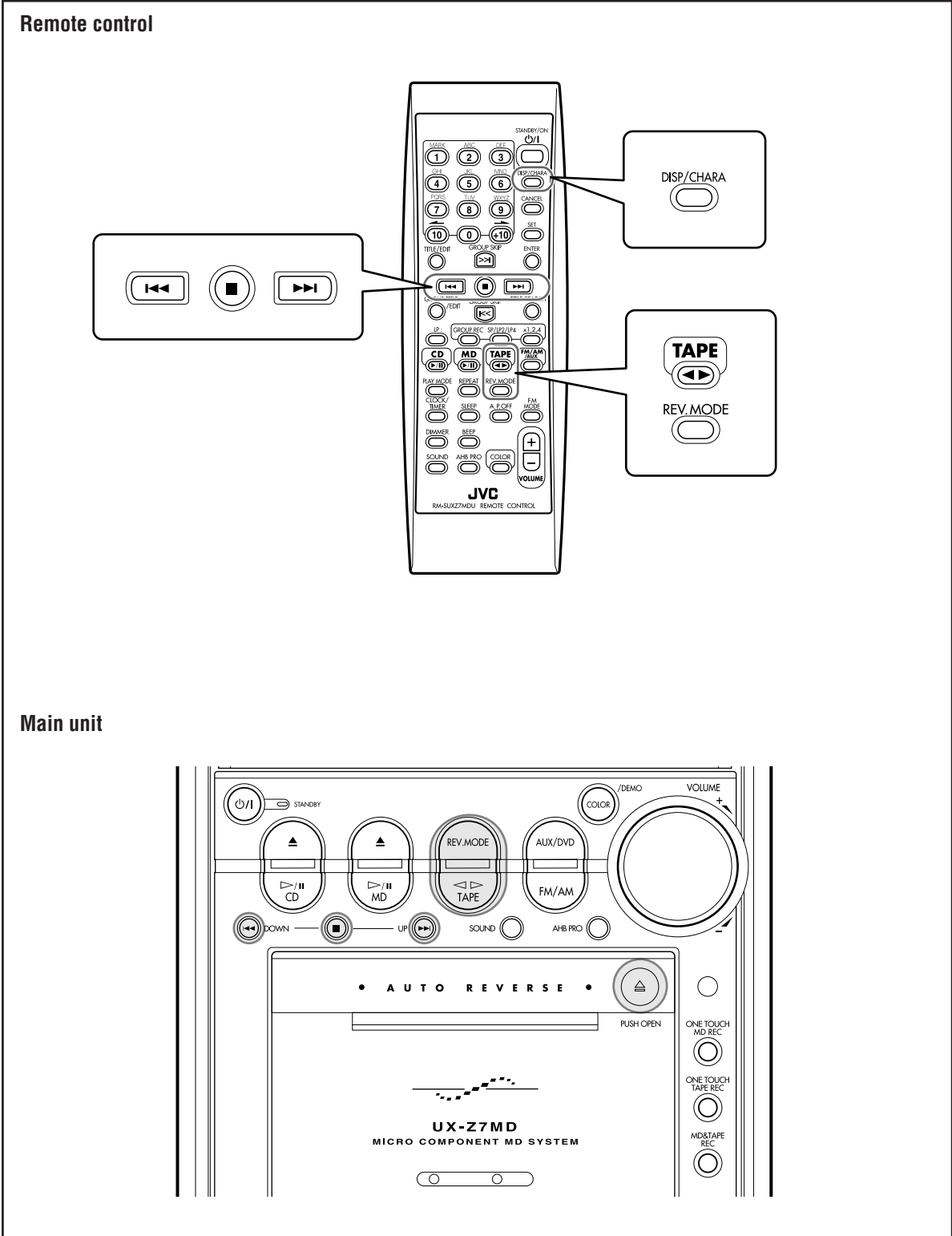

Playing Back a Tape

You can play back type I tapes.

1 Push \triangle (PUSH OPEN).

The cassette holder opens.

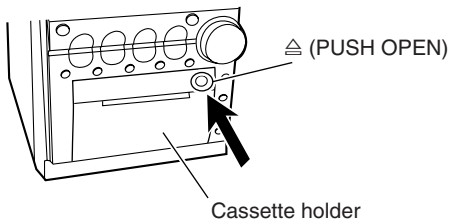

2 Put a cassette in with the exposed part of the tape down.

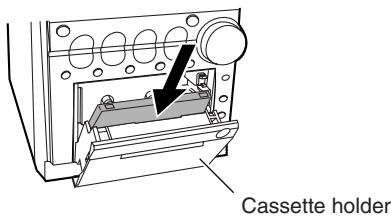

3 Push \triangle (PUSH OPEN) gently to close the cassette holder.

4 Press TAPE $\blacktriangleleft\blacktriangleright$.

The unit automatically turns on and the tape play starts.

- Each time you press the button, the tape direction changes as follows:

- : Plays the front side (left to right).
- : Plays the reverse side (right to left).

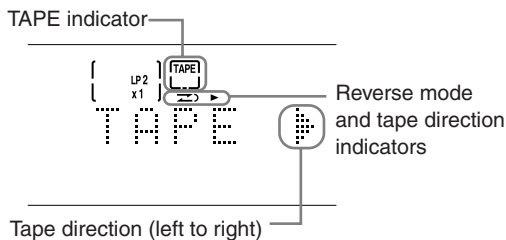

When the tape plays to the end, the deck automatically stops if the reverse mode is set to or . (See “To play both sides—Reverse mode” in the right column.)

To stop during play, press \blacksquare .

To fast-wind to the left, press $\blacktriangleleft\blacktriangleleft$.

To fast-wind to the right, press $\blacktriangleright\blacktriangleright$.

To remove the cassette, push \triangle (PUSH OPEN).



DO NOT push \triangle (PUSH OPEN) during tape play.

To play both sides—Reverse mode

You can set the deck to play just one side or both sides of a tape once, or both sides continuously.

Press REV.MODE.

- Each time you press the button, the reverse mode changes as follows:



- : Plays back only one side (front or reverse).
- : Plays back the front and reverse sides once.
- : Plays back both front and reverse sides continuously.

To change the information shown in the main display

On the remote control ONLY:

Each time you press DISP/CHARA, the information in the main display alternates between the source indication and the clock indication.

- If an MD is inserted, the MD remaining recording time (“REC REMAIN”) is shown before the clock indication.



- The use of the C-120 or thinner tape is not recommended, since characteristic deterioration may occur and this tape easily jams in the pinch rollers and the capstans.
- You can also play back type II and type IV tapes, however, the sound quality (tone) may not be reproduced properly.

Listening to External Equipment

The buttons emphasized in the illustration below are used and explained in this section (page 32).

Remote control

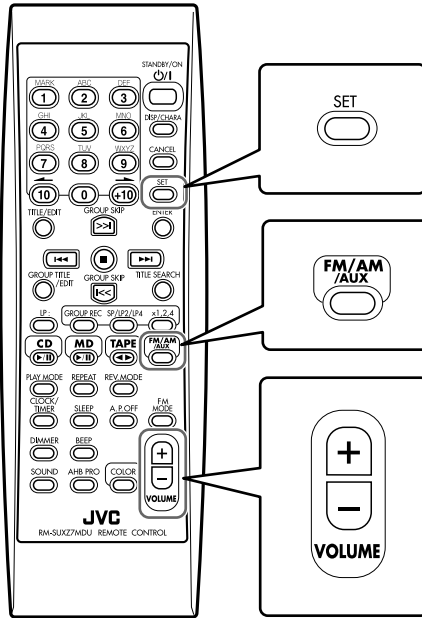

Main unit

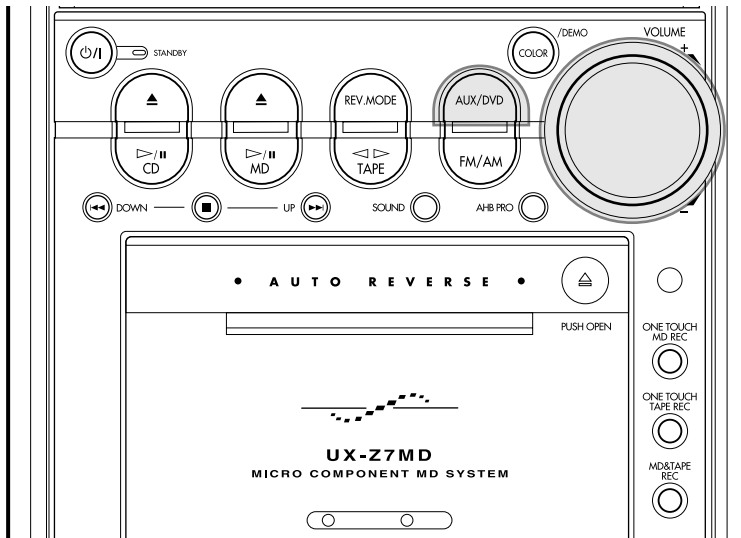

Listening to External Equipment

You can listen to external equipment connected to the AUX/DVD jacks on the rear of the unit.

- First make sure that the external equipment is properly connected as follows:

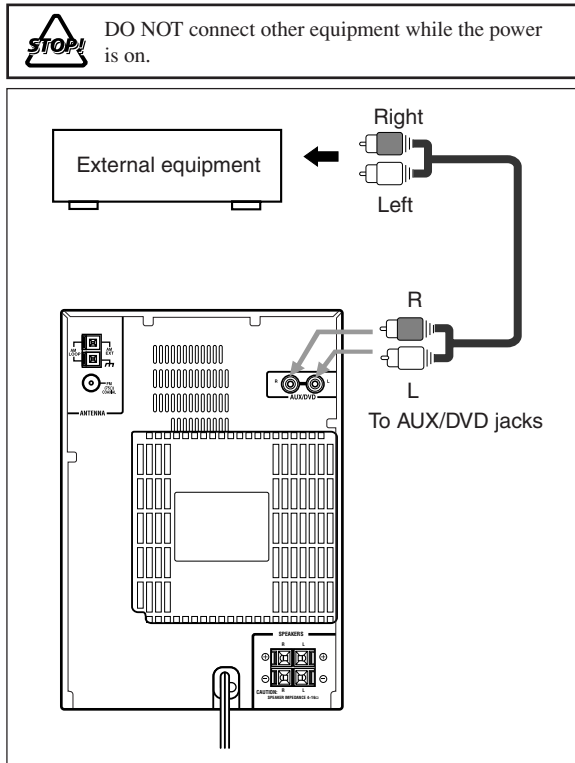

- 1 Press FM/AM/AUX (or AUX/DVD on the main unit) repeatedly so that “AUX” appears in the main display.

On the remote control:

- Each time you press the button, the source changes as follows:

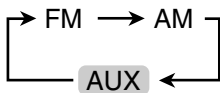

- 2 Adjust the volume level of the unit to “VOLUME 0.”

- 3 Start playing the external equipment.

- For operation of the external equipment, see the manuals supplied with it.

- 4 Adjust the volume level of the unit to your desired listening level.

- 5 Apply sound effects, if you wish.

- For how to apply sound effects, see page 14.

Adjusting the Audio Input Level

If the sound from the component connected to the AUX/DVD jacks is too loud or is not loud enough when changing from another source to “AUX” (without changing the volume level), you can change the audio input level through the AUX/DVD jacks.

- 1 Press FM/AM/AUX (or AUX/DVD on the main unit) repeatedly so that “AUX” appears in the main display.

On the remote control:

- Each time you press the button, the source changes as follows:



- 2 Press and hold SET on the remote control for more than 2 seconds.

- Each time you press and hold the button, the audio input level alternates between “LEVEL 1” and “LEVEL 2.”

“LEVEL 1”: Select this when the sound is too loud (initial setting).

“LEVEL 2”: Select this when the sound is not loud enough.



To change the information shown in the main display

On the remote control ONLY:

Each time you press DISP/CHARA, the information in the main display alternates between the source indication and the clock indication.

- If an MD is inserted, the MD remaining recording time (“REC REMAIN”) is shown before the clock indication.

Recording

The buttons emphasized in the illustration below are used and explained in this section (pages 34 to 40).
For recording operations, you mainly use the buttons on the main unit.

Main unit

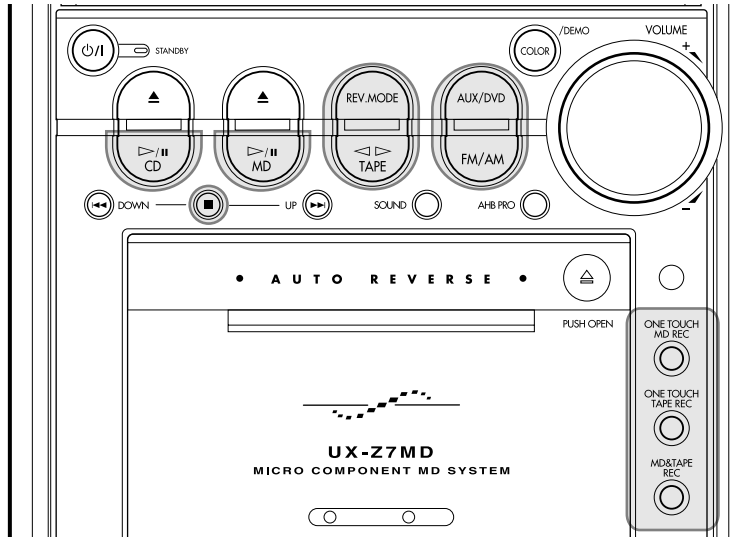

Remote control

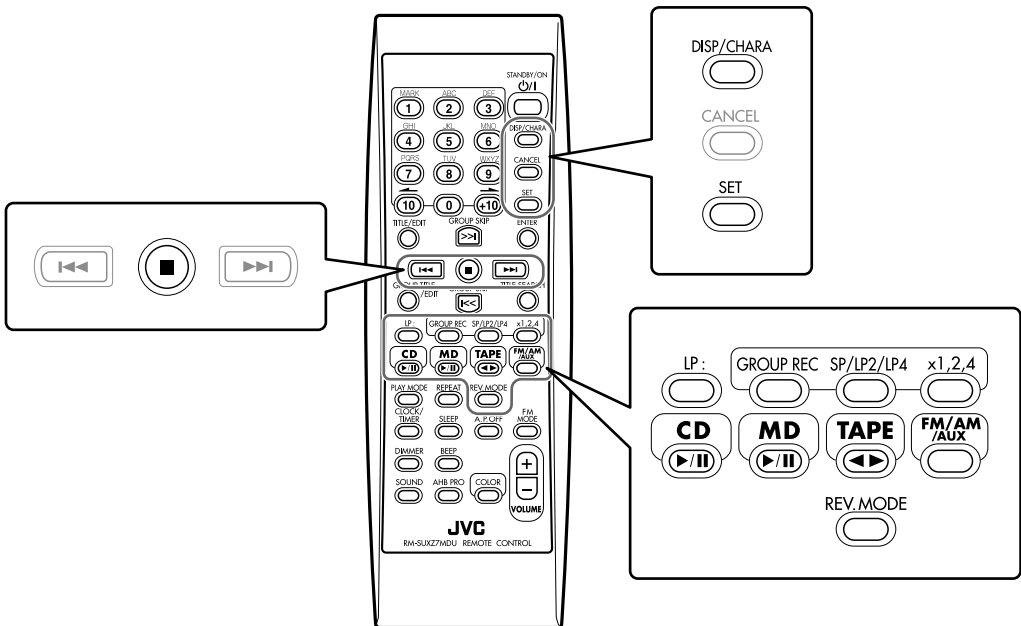

Before You Start Recording on an MD

- It may be unlawful to record or play back copyrighted material without the consent of the copyright owner.
- When you record onto partially recorded MD, its contents are not erased or overwritten. The recording starts from the point following the last recorded track of the MD.
If you want to record on such an MD from the beginning, you have to erase its contents first (see “Erasing All Tracks —ALL ERASE” on page 55).
- When an MD is fully recorded, recording will stop automatically.
- The recording level is automatically set correctly, so it is not affected by the volume level. Thus, during recording you can adjust the sound you are actually listening to without affecting the recording level.
- While recording, you can hear sound mode effect and/or the AHB PRO (Active Hyper Bass PRO) effect through the speakers or headphones. However, the sound is recorded without these effects (see pages 14).
- You can make a digital recording from an audio CD onto an MD.
When selecting FM, AM, TAPE or AUX as the source, you can make an analog recording only.
- You cannot record more than 254 tracks onto an MD, even if there is still enough recording time remaining on it.

About the track marks

When playing an MD, you can move among the tracks. You can do this because there is a mark recorded at the beginning of each track enabling you to locate the track. This mark is called a “**track mark**” and the portion between two adjacent track marks is called a “**track**.”

- **When using CD synchronized recording**, a track mark is recorded at the beginning of each track. You cannot put a track mark manually.
- **When recording from an analog source such as FM/AM broadcasts**, no track mark is recorded on the MD. This means that, when playing this MD, the MD recorder will regard the entire recording as one track (track 1). You will not be able to select directly a song or navigate through songs.

However, if there is a blank of 3 seconds or more, the MD recorder will consider it as a blank separating 2 tracks and consequently put a track mark.

To put a track mark manually while recording an analog source, press SET on the remote control at the place where you want to put a track mark.

To add a track mark after recording is over, you can use the DIVIDE function (see page 52).

To avoid erasing important recordings

The recordable MD has an erasure prevention tab so that important recordings are not accidentally erased. When you finish recording or editing, slide to open the erasure prevention tab on the cartridge side surface. New recording or editing is now no longer possible. (If you try to do, “DISC PROTECTED” appears in the main display.)

To do re-recording or editing, return the tab to the closed position.

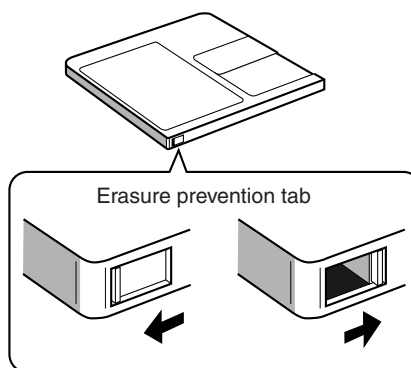

Recording/Editing possible

Disc protected:
Recording/Editing not possible



If “PLAYBACK DISC” appears in the main display when you try to record on an MD

The MD is only for playback use, not for recording (see page 68).

Stereo Long-Hour Recording (MDLP)

On conventional MD recorders, 2 times long-hour recording on MDs has been possible only in monaural sound, but this unit allows for 2 times or 4 times long-hour recording without losing stereo sound.

With this feature, songs (tracks) can be recorded on a single MD using different recording length modes—SP: Standard Play, LP2: 2 Times Long Play, LP4: 4 Times Long Play.

SP: Signifies standard-hour stereo recording. The amount of time usable for recording is the same as shown on the package of the MD.

LP2: Signifies 2 times long-hour stereo recording. The amount of time usable for recording is twice as long as shown on the package of the MD.

LP4: Signifies 4 times long-hour stereo recording. The amount of time usable for recording is 4 times as long as shown on the package of the MD.

REMEMBER to check the remaining recording time of MDs before starting recording

The remaining recording time of MDs will be calculated and shown, based on the recording length mode (SP/LP2/LP4) currently selected.

Before starting recording or using the Recording Timer, check the recording time remaining on the MD for each recording length mode (SP/LP2/LP4) and select the optimum recording length mode.

To check the remaining recording time

- 1 Load an MD to record on.
- 2 Select the source to record.
- 3 Press DISP/CHARA repeatedly until “REC REMAIN” and the remaining time based on the current recording mode* appear in the main display.

* When the source is “MD,” the remaining time will be shown based on SP mode.

Precautions for performing long-hour stereo recording

After having made long-hour stereo recordings on this unit, pay attention to the following:

- Songs (tracks) recorded in 2 times or 4 times long-hour recording mode can only be played back on the equipment provided with MDLP, compatible with a long-hour stereo recording function; otherwise, “LP:” is displayed before a title and playback proceeds without sounds.
- When editing songs (tracks) on an MD, you cannot join (JOIN) songs (tracks) recorded in different recording length modes (SP/LP2/LP4).



More about MDLP

- You cannot make a long-hour monaural recording using this unit.
- Sound quality will decrease as the recording length mode changes to LP2 (little) and LP4 (much). To obtain the best sound quality, it is recommended to use the SP mode when recording.

About High-Speed Recording

The time for high-speed recording is half or quarter as long as the time for normal speed recording.

There are some restrictions to observe for high-speed recording (x2 speed recording: two times as quick as normal speed recording, x4 speed recording: four times as quick as normal speed recording) to protect copyrights. (HCMS: see page 66.)

This unit is so designed that a song (track) recorded from a CD using high-speed recording cannot be re-recorded until 74 minutes elapse after the previous recording started.

If you try to re-record the same song (track) within the 74 minutes, recording is canceled and “HCMS CANNOT COPY” appears in the main display as a warning.

REMEMBER if you are trying to record a program including the same song (track) twice using high-speed recording, recording will stop at the beginning of the 2nd recording of the same song (track). (“HCMS CANNOT COPY” will appear in the main display.)



During high-speed recording

You cannot listen to any source, and therefore, cannot adjust the volume level. (“CANNOT LISTEN” will appear if you try to do.)



About x4 speed recording

- You can select x4 speed recording only when you select SP as recording length mode.
- When you select x4 speed recording, you cannot record using Program or Random play mode.

Setting MD Recording Modes

Before recording on MDs, set the recording length mode (SP/LP2/LP4), "LP:"-prefix addition mode, and the group recording mode.

On the remote control ONLY:

To set the recording length mode

The recording length mode can be set and stored for each source.

1) Select the source to record.

2) Press SP/LP2/LP4.

- Each time you press the button, the recording length mode changes as follows:
 - SP:** Records using standard-hour stereo recording. The SP indicator lights up on the display.
 - LP2*:** Records using 2 times long-hour stereo recording. The LP2 indicator lights up on the display.
 - LP4*:** Records using 4 times long-hour stereo recording. The LP4 indicator lights up on the display.

* When you select LP2 or LP4, you cannot record a disc using x4 speed recording.

To set "LP:"-prefix addition mode

You can select whether or not to add "LP:" to the head of the title for the tracks recorded using the stereo long-hour recording mode (LP2 or LP4).

Press LP:.

- Each time you press the button, the "LP:"-prefix addition mode alternates between on and off.

"(LP:) ON":

Adds "LP:" to the head of the track title. The total number of characters you can enter for an MD is reduced (for details, see page 56).

"(LP:) OFF":

Does not add "LP:" to the head of the track title.

To set Group recording mode

You can form a new group easily while recording using Group recording function.

Press GROUP REC.

- Each time you press the button, Group recording function turns on and off.

"MD GROUP ON":

All the tracks recorded at a time will form a new group. The GROUP indicator lights up on the display.

"MD GROUP OFF":

Cancels Group recording function. The GROUP indicator goes off from the display.

Recording CD onto an MD—CD Synchronized Recording

Using the CD synchronized recording method, you can start and stop CD play and MD recording at the same time.

1 Prepare a disc.

After placing a disc, press CD ►/||, then ■ before going to the next step.

- You can make a program (see page 21) or select Random play mode (see page 22) if you want.

2 Insert a recordable MD into the MD loading slot.

- Set the MD recording length mode, "LP:"-prefix addition mode, and Group recording mode (see the left column).

3 Press x1,2,4 on the remote control to select the recording speed you want.

- Each time you press the button, the recording speed changes as follows:

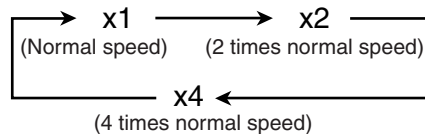

4 Press ONE TOUCH MD REC on the main unit.

The recording starts and the MD REC indicator starts flashing on the display.

- When you select a track by pressing ►► or ◀◀ before pressing ONE TOUCH MD REC, recording starts from the selected track (except when Program play mode is selected).
- When you select Program play or Random play mode, you cannot record using x4 speed recording ("CANNOT REC x1 or x2 ONLY" will appear).

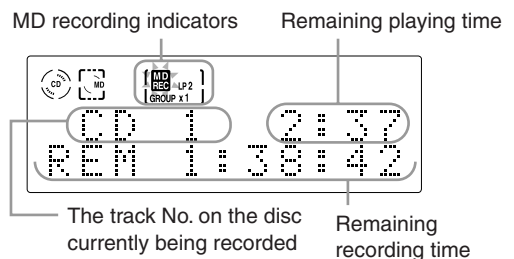

Ex.: Track 1 of a disc is now recorded on an MD using LP2 and Group recording at normal speed (x1).

After the recording, both the CD player and the MD recorder stop automatically.

To stop recording, press ■.

"WRITING" flashes in the main display for a while.

To record a single track during play or pause

On the main unit ONLY:

While playing back or pausing a track you want to record, press ONE TOUCH MD REC.

The playback of the track is stopped, and the same track starts playing from the beginning again. This time, the MD recorder starts recording the track.

- After the track is recorded, both the CD player and the MD recorder stop automatically.

To change the information shown in the main display

On the remote control ONLY:

Press DISP/CHARA.

- Each time you press the button, the recording indications, the current track numbers of both the disc and the MD, and the clock indication appear in sequence in the main display.



When recording from a CD-R/RW

You cannot make a digital recording from a digital-copied CD-R/RW on an MD. "SCMS CANNOT COPY" appears in the main display and an analog recording starts (see page 68). The recording speed is automatically set to x1 (normal speed).

Recording Other Sources onto an MD

1 Prepare the source to record.

To record FM/AM broadcasts:

Press FM/AM (or FM/AM/AUX on the remote control) to select either "FM" or "AM," then tune in to a preset station you want.

- For more detailed operations, see pages 17 and 18.

To record a tape:

- 1) After putting a cassette, press TAPE ◀▶, then ■ to select TAPE as the source.
- 2) Press REV.MODE to select the reverse mode (see page 30).

To record external equipment:

Press AUX/DVD (or FM/AM/AUX on the remote control) to select "AUX" and prepare the external equipment to play.

- Adjust the audio input level if necessary (see page 32).
- For operation of the external equipment, see the manuals supplied with it.

2 Insert a recordable MD into the MD loading slot.

- Set the MD recording length mode, "LP:"-prefix addition mode, and Group recording mode (see "Setting MD Recording Modes" on page 36).

3 Press ONE TOUCH MD REC on the main unit.

The recording starts and the MD REC indicator starts flashing on the display.

- When recording the external equipment, start playback after "AUX → MD" appears in the main display.

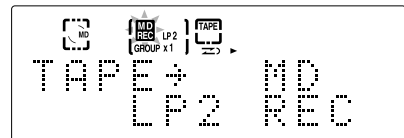

Ex.: When recording a tape using LP2 and Group recording.

To put a track mark manually while recording, press SET on the remote control at the place where you want.

To stop recording, press ■.

"WRITING" flashes in the main display for a while.



When recording the external equipment

Recording starts automatically when the source sound comes into the unit, and stops automatically if no sound comes into the unit for more than 30 seconds (Sound synchronized recording).

To change the information shown in the main display

On the remote control ONLY:

Press DISP/CHARA.

- Each time you press the button, the information in the main display changes as follows:

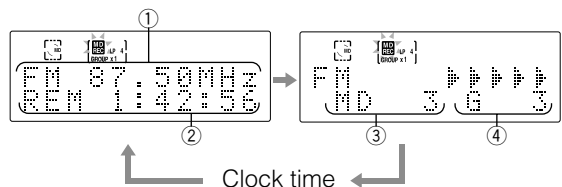

Ex.: When you record an FM broadcast.

- ① Source indication
- ② Remaining recording time
- ③ MD track No.
- ④ MD group No. (When Group recording is not activated, "—" will appear.)

Before You Start Recording on a Tape

- It may be unlawful to record or play back copyrighted material without the consent of the copyright owner.
- The recording level is automatically set correctly, so it is not affected by the volume level. Thus, during recording you can adjust the sound you are actually listening to without affecting the recording level.
- While recording, you can hear sound mode effect and/or the AHB PRO (Active Hyper Bass PRO) effect through the speakers or headphones. However, the sound is recorded without these effects (see pages 14).
- If recordings you have made have excessive noise or static, the unit may be too close to a TV. Place the unit away from the TV.
- You can use only type I tapes for recording.

To protect your recordings

Cassettes have two small tabs on the back to protect unexpected erasure or recording.

To protect your recording, remove these tabs.

To re-record on a protected tape, cover the holes with adhesive tape.

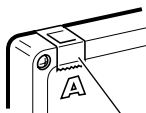

Adhesive tape



Do not use type II and type IV tapes since the unit is not compatible with such tapes.



The use of the C-120 or thinner tape is not recommended, since characteristic deterioration may occur and this tape easily jams in the pinch rollers and the capstans.

To keep the best recording and playback sound quality

If the heads, capstans, and pinch rollers of the cassette deck become dirty, the following will occur:

- Loss of sound quality
- Discontinuous sound
- Fading
- Incomplete erasure
- Difficulty in recording

To clean the heads, capstans, and pinch rollers

Use a cotton swab moistened with alcohol.

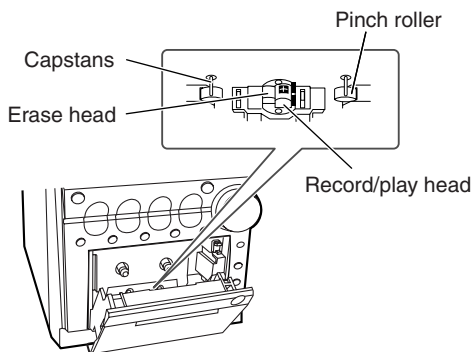

To demagnetize the head

Turn off the unit, and use a head demagnetizer (available at electronics and audio shops).



At the start and end of cassette tapes

There is leader tape which cannot be recorded onto. Thus, when recording discs, MDs, or radio broadcasts, wind the leader tape first to ensure that the recording will be made without any music part lost.

Recording onto a Tape

You can use only type I tapes for recording.

1 Prepare the source to record.

To record a disc:

Prepare a disc.

After placing a disc, press CD ►/II, then ■ to change the source to "CD."

- You can make a program (see page 21) or select Random play mode (see page 22) if you want.

To record an MD:

Prepare an MD.

After inserting an MD, press MD ►/II, then ■ to change the source to "MD."

- You can make a program (see page 25) or select Random play mode (see page 26) or Group play mode (see page 27) if you want.

To record FM/AM broadcasts:

Press FM/AM (or FM/AM/AUX on the remote control) to select either "FM" or "AM," then tune in to a preset station you want.

- For more detailed operations, see pages 17 and 18.

To record external equipment:

Press AUX/DVD (or FM/AM/AUX on the remote control) to select "AUX" and prepare the external equipment to play.

- Adjust the audio input level if necessary (see page 32).
- For operation of the external equipment, see the manuals supplied with it.

2 Put a recordable cassette into the cassette holder.

3 Press REV.MODE to select a reverse mode.

- Each time you press the button, the reverse mode changes as follows:

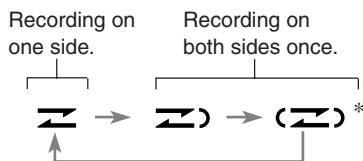

- * will be shown during recording when you select .

4 Press ONE TOUCH TAPE REC on the main unit.

The recording starts and the REC indicator starts flashing on the display.

- When you select a track by pressing ►► or ◀◀ before pressing ONE TOUCH TAPE REC, recording starts from the selected track (except when Program play mode is selected).
- When recording an external equipment, start playback after "AUX → TAPE" appears in the main display.

To stop recording, press ■.

To record a single track of a CD/MD during play

On the main unit ONLY:

While playing back a disc track or an MD track you want to record, press ONE TOUCH TAPE REC.

The playback of the track is stopped, and the same track starts playing from the beginning again. This time, the cassette deck starts recording the track.

- After the track is recorded, both playback and recording stop automatically.



When you press ONE TOUCH TAPE REC while pausing a track

Recording starts from that point.

To change the information shown in the main display

On the remote control ONLY:

Press DISP/CHARA.

- Each time you press the button, the information in the main display alternates between the recording indication and the clock indication.



When recording a disc or an MD

- A 4-second blank is automatically made on the tape before each track. To record without the blank, press CD ►/II or MD ►/II twice in step 1, then press ONE TOUCH TAPE REC.
- When the front side of the tape ends in the middle of a track, the recording on the reverse side starts from the beginning of that track (if the reverse mode is set to). However, if the front side ends within 12 seconds from the beginning of a track, recording on the reverse side starts from the previous track.

Recording CD onto an MD and a Tape —CD Synchronized Recording

With this recording method, you can start and stop CD play, MD and tape recordings at the same time.

1 Prepare a disc.

After placing a disc, press CD ►/||, then ■ before going to the next step.

- You can make a program (see page 21) or select Random play mode (see page 22) if you want.

2 Insert a recordable MD into the MD loading slot and put a recordable cassette into the cassette holder.

For the MD:

Set the MD recording length mode, “LP:”-prefix addition mode, and Group recording mode (see “Setting MD Recording Modes” on page 36).

For the tape:

Press REV.MODE to select the reverse mode (◀▶).

3 Press x1,2,4 on the remote control to select x1 (normal speed recording).

- You cannot use x2 or x4 speed recording. (If you try to do so, “CANNOT REC x1 REC ONLY” will appear in step 4 below.)

4 Press MD&TAPE REC.

CD play and the recording start.

- When you select a track by pressing ►► or ◀◀ before pressing MD&TAPE REC, recording starts from the selected track (except when Program play mode is selected).

The MD REC and REC indicators start flashing on the display.

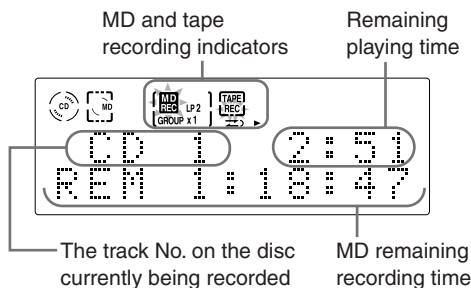

After the recording, the CD player, MD recorder and the cassette deck stop automatically.

To record a single track during play or pause

On the main unit ONLY:

While playing back or pausing a track you want to record, press MD&TAPE REC.

The playback of the track is stopped, and the same track starts playing from the beginning again. This time, the MD recorder and cassette deck start recording the track.

- After the track is recorded, both playback and recording stop automatically.

To change the information shown in the main display

On the remote control ONLY:

Press DISP/CHARA.

- Each time you press the button, the information in the main display alternates between the recording indication and the clock indication.



When recording from a CD-R/RW

You cannot make a digital recording from a digital-copied CD-R/RW on an MD. “SCMS CANNOT COPY” appears in the main display and an analog recording starts (see page 68).



When recording on an MD and a tape at the same time

A 4-second blank before each track is not made on the tape.

To stop recording, press ■.

“WRITING” flashes in the main display for a while.

Editing MDs

The buttons emphasized in the illustration below are used and explained in this section (pages 42 to 58).

Remote control

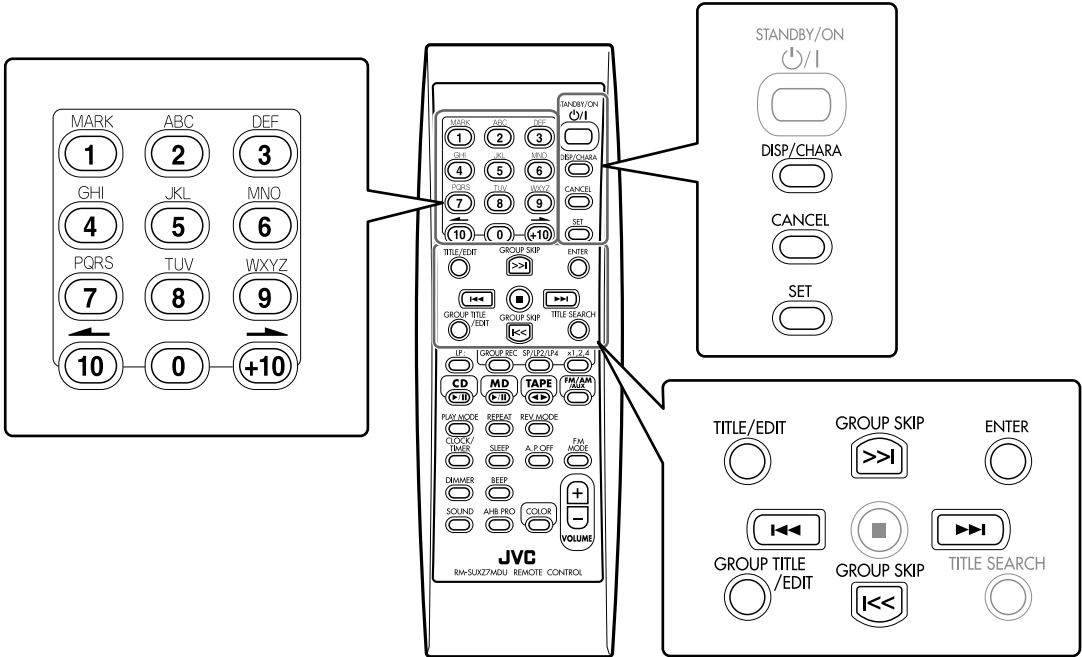

Main unit

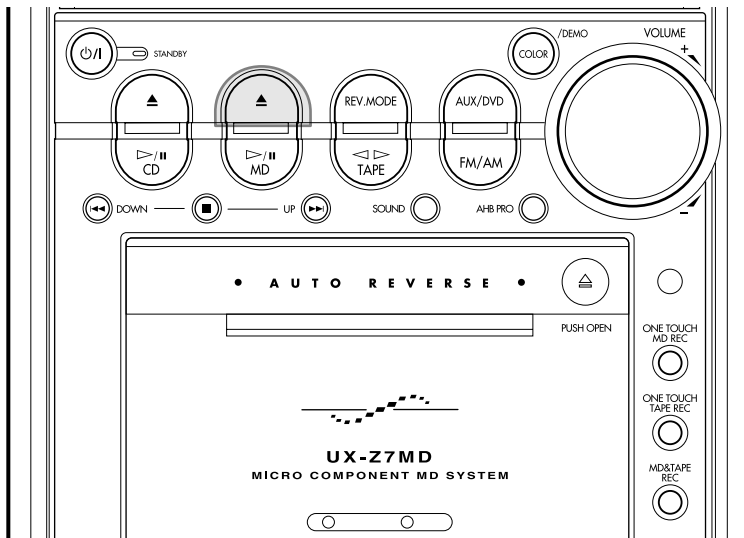

Guidance—MD Group Functions

To add to the conventional MD Editing functions (called the track editing functions in this manual), MD Group functions help you to classify the tracks by making groups on your MD.

Classifying the tracks on an MD

MDLP enables you to record more tracks on a single MD than usual. So, there are many tracks which have been recorded from the various sources—CDs, FM, and so on—on your MD.

In that case, if you can classify the tracks by source, by album, or by artist, the playback of your favorite songs becomes much easier.

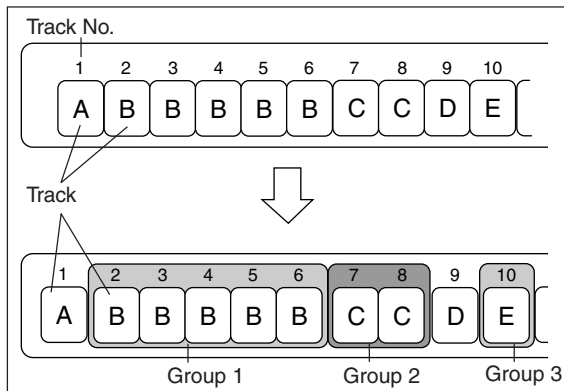

In the figure above, as an example, there are 5 different genres (from A to E) of tracks on the MD. Using MD Group functions, you can form a group by genre B tracks as Group 1.

By forming groups on the MD, you can classify the tracks by each genre—the album title, the artist, etc. You can also assign a name to each group (see pages 56 – 58).

Using MD Group functions

MD Group functions consist of Group play, Group recording and Group editing.

• Group play (see page 27):

You can play back and repeat the desired group without making a program: For example, you can play back repeatedly genre B tracks by selecting Group 1 in the left figure.

• Group recording (see page 36):

You can form a group while tracks are being recorded.

• Group editing:

You can edit the groups using the following functions:

- Forming a group (FORM GR)
- Adding a track to a group (ENTRY GR)
- Dividing a group (DIVIDE GR)
- Joining two groups (JOIN GR)
- Moving a group (MOVE GR)
- Ungrouping tracks (UNGROUP)
- Dissolving all groups (UNGR ALL)
- Erasing tracks in a group (ERASE GR)

How to make up Groups

You can make up groups using two methods: Forming-a-group function and Group recording function.

• Forming-a-group function—FORM GR:

Select this when you want to make groups after recording (see page 44).

• Group recording function:

Select this when you want to record and group tracks at the same time (see page 36).



About information concerning MD Group functions

Once you edit an MD using MD Group functions, the MD is assigned some characters as the information concerning MD Group functions. These characters appear only when you play back the MD using the equipment incompatible with MD Group functions. If you edit the characters using such equipment, the groups on the MD will be dissolved.

Introducing Group Editing Functions

The groups and tracks can be edited in many ways (Group editing functions and Track editing functions). From this page to page 50, the group editing functions are explained. For details on the track editing functions, see pages 51 to 55.

Forming a group (FORM GR): Page 44

This function forms a series of tracks or a single track into a new group.

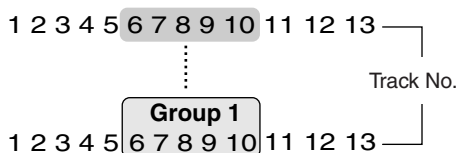

Adding a track to a group (ENTRY GR): Page 45

This function enters the selected track into a group.

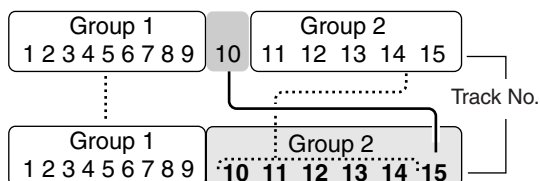

Dividing a group (DIVIDE GR): Page 46

This function divides a group containing plural tracks.

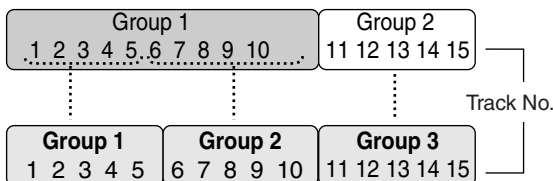

Joining two groups (JOIN GR): Page 47

This function joins two adjacent groups into a single group.

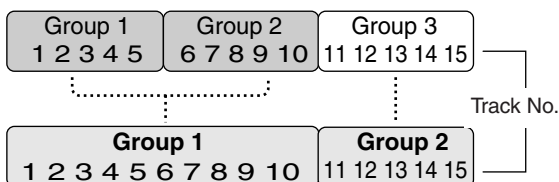

Moving a group (MOVE GR): Page 48

This function moves the selected group by reordering the group and track numbers.

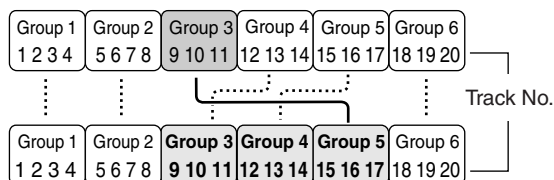

Ungrouping tracks (UNGROUP): Page 49

This function dissolves a group.

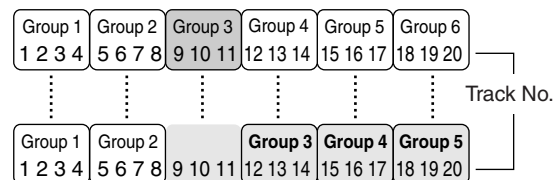

Dissolving all groups (UNGR ALL): Page 49

This function dissolves all the groups.

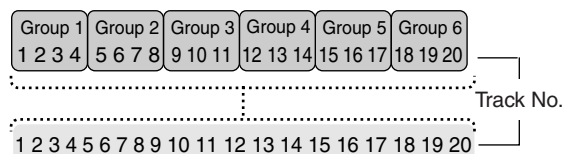

Erasing tracks in a group (ERASE GR): Page 50

This function erases the tracks in the selected group.

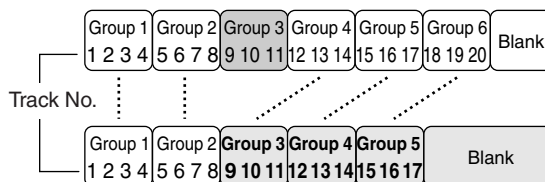

If "PLAYBACK DISC" or "DISC PROTECTED" appears when you try to edit an MD You cannot edit such MDs. See pages 67 and 68.



During Program play or Random play mode You can edit the MD as long as the playback is stopped. However, editing groups and/or tracks will resume Normal play mode (the program in memory will be cleared).

Forming a Group—FORM GR

This function allows you to form a group from a series of tracks which do not belong to the other groups. You can form a group from a single track.

Once a new group is formed, the other groups are renumbered.

- You can form up to 99 groups on a single MD.
- To stop any time during the editing process before step 8, press GROUP TITLE/EDIT.

On the remote control ONLY:

In the following example, the process is explained from the very first—that is, inserting a disc. You can also edit an MD during playback (in Normal play mode).

1 Insert an MD you want to edit into the MD loading slot.

2 Press GROUP TITLE/EDIT repeatedly until “FORM GR ?” appears in the main display.

FORM GR ?
YES? → SET

- If you want to stop this editing process, press CANCEL.

3 Press SET.

T 1 → T - - - ?
OK? → SET

- **During playback:**
The currently playing track number starts flashing.

4 Press ►► or ◀◀ to select the first track of a new group.

- You can select the track using the number buttons. In this case, the selected track starts playback repeatedly.

T 3 → T - - - ?
OK? → SET

Ex.: When track 3 is selected.

5 Press SET.

- If the selected first track belongs to another group, “GROUP TRACK” appears in the main display. Select the track correctly in step 4 again.
- If you want to form a group from the selected track only, go to step 7.
- To cancel the setting, press CANCEL, then repeat from step 4.

6 Press ►► or ◀◀ to select the last track of the new group.

- You can select the track using the number buttons. In this case, the selected track starts playback repeatedly.

T 3 → T 5 ?
OK? → SET

Ex.: When track 5 is selected.

7 Press SET.

<FORM GR>
YES? → ENTER

- If the selected last track belongs to another group, “GROUP TRACK” appears in the main display. Select the track correctly in step 6 again.
- To cancel the setting, press CANCEL, then repeat from step 4.

8 Press ENTER.

“EDITING” appears in the main display for a while, then “WRITING” and the MD REC indicator flash while the editing you have made is being recorded on the MD.

To dissolve the group again, see the UNGROUP function on page 49.



When “CANNOT FORM!” appears in step 7

You are trying to form a new group which includes another group between the first and the last track. In this case, dissolve the previous group and form a new one again.

Adding a Track to a Group—ENTRY GR

This function allows you to enter a track into a group. The track will be added as the last track in the selected group. The track numbers will be renumbered.

- To stop any time during the editing process before step **8**, press GROUP TITLE/EDIT.

On the remote control ONLY:

In the following example, the process is explained from the very first—that is, inserting a disc. You can also edit an MD during playback (in Normal play mode).

1 Insert an MD you want to edit into the MD loading slot.

2 Press GROUP TITLE/EDIT repeatedly until “ENTRY GR ?” appears in the main display.

ENTRY GR ?
YES? → SET

- If you want to stop this editing process, press CANCEL.

3 Press SET.

TR ? → SET

- **During playback:**
The currently playing track number starts flashing.

4 Press ►► or ◀◀ to select the track.

- You can select the track using the number buttons. In this case, the selected track starts playback repeatedly.

TR ? → SET

Ex.: When track 13 is selected.

5 Press SET.

GROUP -- ?
OK? → SET

- If the loaded MD has no group, you cannot go to the following steps.
- When the selected track belongs to a group, its group number appears in the main display.
- To cancel the setting, press CANCEL, then repeat from step **4**.

6 Press GROUP SKIP ►► or GROUP SKIP ◀◀ to select the group.

GROUP 18 ?
OK? → SET

Ex.: When group 18 is selected.

7 Press SET.

< ENTRY GR >
YES? → ENTER

- To cancel the setting, press CANCEL, then repeat from step **4**.

8 Press ENTER.

“EDITING” appears in the main display for a while, then “WRITING” and the MD REC indicator flash while the editing you have made is being recorded on the MD.



When “CANNOT ENTRY!” appears in step **7** You are trying to enter the selected track into the same group again. Repeat procedure from step **6**.

Dividing a Group—DIVIDE GR

This function allows you to divide one group into two separate groups.

You cannot divide the group containing only a single track. When the original group has a title, two separate groups are reassigned the same title as the original group.

Once a new group is divided, the other groups are renumbered.

- To stop any time during the editing process before step 7, press GROUP TITLE/EDIT.

On the remote control ONLY:

In the following example, the process is explained from the very first—that is, inserting a disc. You can also edit an MD during playback (in Normal play mode).

1 Insert an MD you want to edit into the MD loading slot.

2 Press GROUP TITLE/EDIT repeatedly until “DIVIDE GR?” appears in the main display.



DIVIDE GR?
YES? → SET

- If you want to stop this editing process, press CANCEL.

3 Press SET.



G 1 I
OK? → SET

- If the loaded MD has no group, you cannot go to the following steps.

• During playback:

The currently playing track number and its group number will appear. If the track does not belong to any group, the group number will be indicated by “--”

4 Press GROUP SKIP >>1 or GROUP SKIP <<1 to select the group you want to divide.



G 2 I
OK? → SET

The first track of the selected group

Ex.: When group 2 is selected.

5 Press >>1 or <<1 to select the track as the dividing point.

The track selected in this step will be the first track in the divided group.

- You can select the track using the number buttons. In this case, the selected track starts playback repeatedly.



G 2 I
OK? → SET

Ex.: When track 8 is selected.

- You cannot select the first track in a group or an ungrouped track as the dividing point.

6 Press SET.



< DIVIDE GR >
YES? → ENTER

- To cancel the setting, press CANCEL, then repeat from step 4.

7 Press ENTER.

“EDITING” appears in the main display for a while, then “WRITING” and the MD REC indicator flash while the editing you have made is being recorded on the MD.

To join the divided groups again, see the JOIN GR function on page 47.

Joining Two Groups—JOIN GR

This function allows you to join two adjacent groups into a single group.

When the groups have their own titles, the title of the preceding group is reassigned to the joined group. Once two groups are joined, the other groups are renumbered.

- To stop any time during the editing process before step 6, press GROUP TITLE/EDIT.

On the remote control ONLY:

In the following example, the process is explained from the very first—that is, inserting a disc. You can also edit an MD during playback (in Normal play mode).

1 Insert an MD you want to edit into the MD loading slot.

2 Press GROUP TITLE/EDIT repeatedly until “JOIN GR ?” appears in the main display.

JOIN GR ?
YES? → SET

- If you want to stop this editing process, press CANCEL.

3 Press SET.

G 7 + G 8 ?
OK? → SET

- If the loaded MD has only one or no group, you cannot go to the following steps.
- **During playback:**
The group number of the currently playing track will appear on the right. If the track does not belong to any group, the group number will be indicated by “- -”

4 Press GROUP SKIP >>| or GROUP SKIP |<< to select the two adjacent groups you want to join.

G 7 + G 8 ?
OK? → SET

Ex.: When groups 7 and 8 are selected.

5 Press SET.

<JOIN GR>
YES? → ENTER

- To cancel the setting, press CANCEL, then repeat from step 4.

6 Press ENTER.

“EDITING” appears in the main display for a while, then “WRITING” and the MD REC indicator flash while the editing you have made is being recorded on the MD.

To divide the group again, see the DIVIDE GR function on page 46.



When “CANNOT JOIN” appears in step 5

You are trying to join two groups which are separated by another track(s) in-between. In this case, you need to move either of the groups or the track(s).

Moving a Group—MOVE GR

This function allows you to move a group.

Once a group is moved, the tracks and the other groups are renumbered.

- To stop any time during the editing process before step 8, press GROUP TITLE/EDIT.

On the remote control ONLY:

In the following example, the process is explained from the very first—that is, inserting a disc. You can also edit an MD during playback (in Normal play mode).

1 Insert an MD you want to edit into the MD loading slot.

2 Press GROUP TITLE/EDIT repeatedly until “MOVE GR ?” appears in the main display.



MOVE GR
YES? SET

- If you want to stop this editing process, press CANCEL.

3 Press SET.



G +G 1?
OK? SET

- If the loaded MD has only one or no group, you cannot go to the following steps.
- **During playback:**
The group number of the currently playing track will appear. If the track does not belong to any group, the group number will be indicated by “—.”

4 Press GROUP SKIP >>| or GROUP SKIP |<< to select the group you want to move.



G +G 3?
OK? SET

Ex.: When group 3 is selected.

5 Press SET.



G +G 3?
OK? SET

- To cancel the setting, press CANCEL, then repeat from step 4.

6 Press GROUP SKIP >>| or GROUP SKIP |<< to select the position where you want to move the group.



G 10+G 3?
OK? SET

Ex.: When group 3 is moved to group 10.

7 Press SET.



<MOVE GR>
YES? ENTER

- To cancel the setting, press CANCEL, then repeat from step 4.

8 Press ENTER.

“EDITING” appears in the main display for a while, then “WRITING” and the MD REC indicator flash while the editing you have made is being recorded on the MD.

Ungrouping Tracks—UNGROUP

This function allows you to dissolve a group. You cannot erase the tracks using this function. Once tracks are ungrouped, the other groups are renumbered.

- To stop any time during the editing process before step 6, press GROUP TITLE/EDIT.

On the remote control ONLY:

In the following example, the process is explained from the very first—that is, inserting a disc. You can also edit an MD during playback (in Normal play mode).

1 Insert an MD you want to edit into the MD loading slot.

2 Press GROUP TITLE/EDIT repeatedly until “UNGROUP ?” appears in the main display.

```
UNGROUP  ?
YES? → SET
```

- If you want to stop this editing process, press CANCEL.

3 Press SET.

```
GROUP 1 ?
YES? → SET
```

- If the loaded MD has no group, you cannot go to the following steps.
- **During playback:**
The group number of the currently playing track will appear. If the track does not belong to any group, the group number will be indicated by “--.”

4 Press GROUP SKIP >>| or GROUP SKIP <<| to select the group you want to dissolve.

```
GROUP 3 ?
YES? → SET
```

Ex.: When group 3 is selected.

5 Press SET.

```
<UNGROUP>
YES? → ENTER
```

- To cancel the setting, press CANCEL, then repeat from step 4.

6 Press ENTER.

“EDITING” appears in the main display for a while, then “WRITING” and the MD REC indicator flash while the editing you have made is being recorded on the MD.

Dissolving All Groups—UNGR ALL

This function allows you to dissolve all the groups. You cannot erase the tracks using this function.

- To stop any time during the editing process before step 4, press GROUP TITLE/EDIT.

On the remote control ONLY:

In the following example, the process is explained from the very first—that is, inserting a disc. You can also edit an MD during playback (in Normal play mode).

1 Insert an MD you want to edit into the MD loading slot.

2 Press GROUP TITLE/EDIT repeatedly until “UNGR ALL ?” appears in the main display.

```
UNGR ALL ?
YES? → SET
```

- If you want to stop this editing process, press CANCEL.

3 Press SET.

```
<UNGR ALL>
YES? → ENTER
```

- To cancel the setting, press CANCEL.

4 Press ENTER.

“EDITING” appears in the main display for a while, then “WRITING” and the MD REC indicator flash while the editing you have made is being recorded on the MD.

Erasing Tracks in a Group—ERASE GR

This function allows you to erase a group together with tracks in the group.

You cannot resume the tracks in the erased group.

Once a group is erased, the other tracks and groups are renumbered.

- To stop any time during the editing process before step **6**, press GROUP TITLE/EDIT.

On the remote control ONLY:

In the following example, the process is explained from the very first—that is, inserting a disc. You can also edit an MD during playback (in Normal play mode).

1 Insert an MD you want to edit into the MD loading slot.

2 Press GROUP TITLE/EDIT repeatedly until “ERASE GR ?” appears in the main display.

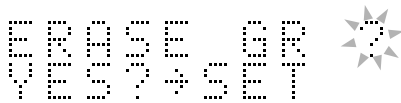

ERASE GR ?
YES? SET

- If you want to stop this editing process, press CANCEL.

3 Press SET.



G 1 ERASE?
ERASE? SET

- If the loaded MD has no group, you cannot go to the following steps.
- **During playback:**
The group number of the currently playing track will appear. If the track does not belong to any group, the group number will be indicated by “—.”

4 Press GROUP SKIP >>| or GROUP SKIP |<< to select the group you want to erase.



G 6 ERASE?
ERASE? SET

Ex.: When group 6 is selected

5 Press SET.



<ERASE GR>
YES? ENTER

- To cancel the setting, press CANCEL, then repeat from step **4**.

6 Press ENTER.

“EDITING” appears in the main display for a while, then “WRITING” and the MD REC indicator flash while the editing you have made is being recorded on the MD.

Introducing Track Editing Functions

The groups and tracks can be edited in many ways (Group editing functions and Track editing functions). From this page to page 55, the track editing functions are explained. For details on the group editing functions, see pages 43 to 50.

Dividing a track (DIVIDE): Page 52

This function divides a track by adding a track mark(s) in the desired point(s) in the middle or where you want to search for later.

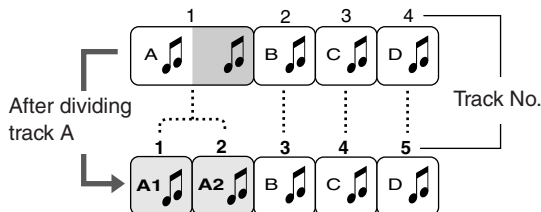

Joining two tracks (JOIN): Page 53

This function joins two adjacent tracks into a single track by deleting a track mark.

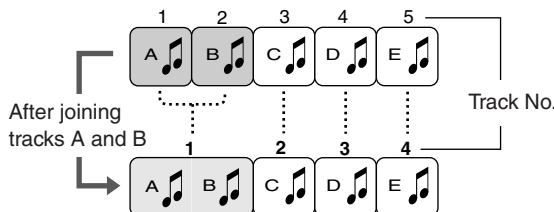

Moving a track (MOVE): Page 54

This function moves a track by reordering the track numbers.

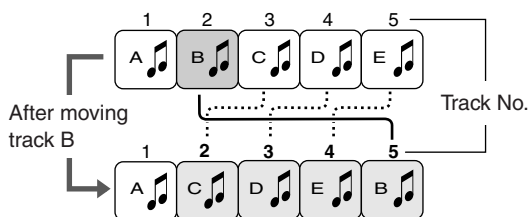

Erasing tracks (ERASE): Page 55

This function erases selected tracks. After the erasure, the subsequent tracks are justified and their track numbers are renumbered automatically. You can erase up to 15 tracks at a time.

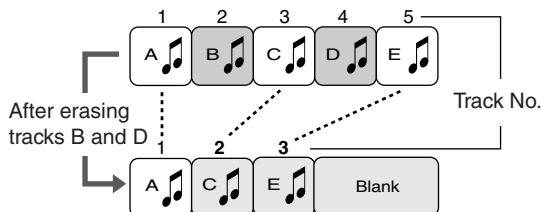

Erasing all tracks (ALL ERASE): Page 55

This function erases data on a disc entirely.

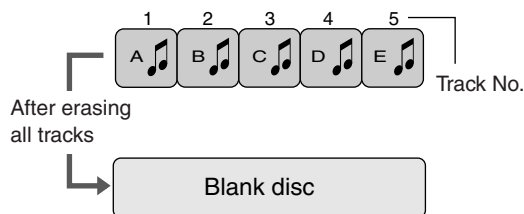

Erasing a portion of a track

By combining "DIVIDE," "ERASE" and "JOIN," for example, it is possible to erase only a part of an existing track.

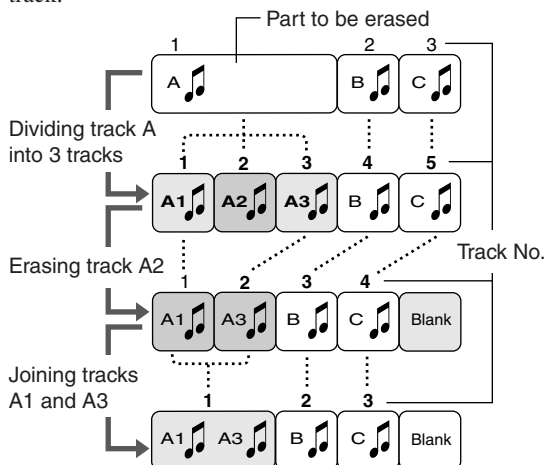

If "PLAYBACK DISC" or "DISC PROTECTED" appears when you try to edit an MD

You cannot edit such MDs. See pages 67 and 68.



During Program play or Random play mode

You can edit the MD as long as the playback is stopped. However, editing groups and/or tracks will resume Normal play mode (the program in memory will be cleared).

Dividing a Track—DIVIDE

This function allows you to divide one track into two separate tracks. It is useful, for example, when you want to add track marks at a certain point within a track or if you want to separate a recording.

When the original track has a title, two separate tracks are reassigned the same title as the original track.

Once a track is divided, the other tracks are renumbered.

- To stop any time during the editing process before step **8**, press TITLE/EDIT.

On the remote control ONLY:

In the following example, the process is explained from the very first—that is, inserting a disc. You can also edit an MD during playback (in Normal play mode).

1 Insert an MD you want to edit into the MD loading slot.

2 Press TITLE/EDIT repeatedly until “DIVIDE ?” appears in the main display.

```
DIVIDE
YES?→SET
```



- If the loaded MD has no track, “DIVIDE ?” will not appear.
- If you want to stop this editing process, press CANCEL.

3 Press SET.
The first track on the MD starts playback repeatedly.

4 Press ►► or ◀◀ to select the track you want to divide.

- You can select the track using the number buttons.

```
12      2:50
YES?→SET
```

Ex.: When track 12 is selected.

- If you press and hold ►► (or ◀◀), you can fast-forward (or fast-reverse) the selected track.

5 Press SET when you find the point where you want to divide the track.

“POSIT. (position) 0” appears in the main display, and the unit repeats the selected point—a 3-second period following the dividing point.

```
POSIT. 0
OK?→SET
```

- If the loaded MD has 254 tracks, “DISC FULL” will appear (see “MD limitations” on page 66) and you cannot go to the following steps.
- If the dividing point is satisfactory, go to step **7**. If not, go to the next step.
- To cancel the setting, press CANCEL, then repeat from step **4**.

6 Press → or ← to precisely adjust the dividing point.

When you stop pressing the buttons, the unit repeats the newly selected dividing point.

- You can shift the dividing point up to ±128. This range (±128) corresponds to approximately ±8* seconds (counted on the basis of SP mode) from the original point (Position 0).

```
POSIT. -103
OK?→SET
```

Ex.: When adjusting the point by -103.

* When the recording length mode of the selected track is “SP.” For “LP2,” it is approximately ±16 seconds, and for “LP4” approximately ±32 seconds.

- When you find the right position, go to the next step.
- To cancel the setting, press CANCEL, then repeat from step **4**.

7 Press SET.

```
<DIVIDE>
YES?→ENTER
```

8 Press ENTER.

“EDITING” appears in the main display for a while, then “WRITING” and the MD REC indicator flash while the editing you have made is being recorded on the MD.

To join the divided tracks again, see the JOIN function on page 53.

Joining Two Tracks—JOIN

This function allows you to join two adjacent tracks into one track.

When the tracks have their own titles, the title of the preceding track is reassigned to the joined track. Once two tracks are joined, the other tracks and/or the groups are renumbered.

- To stop any time during the editing process before step 6, press TITLE/EDIT.

On the remote control ONLY:

In the following example, the process is explained from the very first—that is, inserting a disc. You can also edit an MD during playback (in Normal play mode).

1 Insert an MD you want to edit into the MD loading slot.

2 Press TITLE/EDIT repeatedly until “JOIN ?” appears in the main display.

JOIN ?
YES? → SET

- If the loaded MD has no track, “JOIN ?” will not appear.
- If you want to stop this editing process, press CANCEL.

3 Press SET.

← — — — — → 1 ?
OK? → SET

- If the loaded MD has only one track, you cannot go to the following steps.

4 Press ►► or ◀◀ to select the two adjacent tracks you want to join.

- You can select the tracks using the number buttons*. In this case, the selected track starts playing repeatedly.

2+ 3 ?
OK? → SET

Ex.: When tracks 2 and 3 are selected.

- * Select the succeeding track of two tracks when you use the number buttons.

5 Press SET.

<JOIN>
YES? → ENTER

- To cancel the setting, press CANCEL, then repeat from step 4.

6 Press ENTER.

“EDITING” appears in the main display for a while, then “WRITING” and the MD REC indicator flash while the editing you have made is being recorded on the MD.

To divide the joined tracks, see the DIVIDE function on page 52.



notes If “CANNOT JOIN” appears in step 5

You cannot join the following tracks.

- Tracks recorded using different recording length modes (SP, LP2, LP4). (See page 35.)
- Digital-recording tracks and analog-recording tracks.
- Tracks recorded using monaural long recording method (not possible on this unit) and stereo-recording tracks.



notes When the track belongs to a group

If the preceding track of two tracks you want to join belongs to a group, the newly joined track will belong to that group. On the other hand, if the preceding track does not belong to any group, the newly joined track will not belong to any group even if the succeeding track belongs to a group.

Moving a Track—MOVE

This function allows you to move a track to the position you prefer. It is useful to change the order of the tracks as you like.

Once a track is moved, the tracks and/or the groups are renumbered.

- To stop any time during the editing process before step 8, press TITLE/EDIT.

On the remote control ONLY:

In the following example, the process is explained from the very first—that is, inserting a disc. You can also edit an MD during playback (in Normal play mode).

- 1 Insert an MD you want to edit into the MD loading slot.

- 2 Press TITLE/EDIT repeatedly until “MOVE ?” appears in the main display.



MOVE
YES? → SET

- If the loaded MD has no track, “MOVE ?” will not appear.
- If you want to stop this editing process, press CANCEL.

- 3 Press SET.



OK? → SET

- If the loaded MD has only one track, you cannot go to the following steps.

- 4 Press ►► or ◀◀ to select the track you want to move.

- You can select the track using the number buttons. In this case, the selected track starts playing repeatedly.



OK? → SET

Ex.: When track 3 is selected.

- 5 Press SET.



OK? → SET

- To cancel the setting, press CANCEL, then repeat from step 4.

- 6 Press ►► or ◀◀ to select the position where you want to move the track.

- You can select the track using the number buttons. In this case, the selected track starts playing repeatedly.



OK? → SET

Ex.: When track 3 is moved to track 8.

- If the track selected in this step belongs to a group, the track selected in step 4 will be entered into the same group after moving.

- 7 Press SET.



<MOVE>
YES? → ENTER

- To cancel the setting, press CANCEL, then repeat from step 4.

- 8 Press ENTER.

“EDITING” appears in the main display for a while, then “WRITING” and the MD REC indicator flash while the editing you have made is being recorded on the MD.

Erasing Tracks—ERASE

This function allows you to erase unwanted tracks.
You cannot resume the erased tracks.
Once tracks are erased, the other tracks and/or groups are renumbered.

You can erase up to 15 tracks at a time.

- To stop any time during the editing process before step 8, press TITLE/EDIT.

On the remote control ONLY:

In the following example, the process is explained from the very first—that is, inserting a disc. You can also edit an MD during playback (in Normal play mode).

1 Insert an MD you want to edit into the MD loading slot.

2 Press TITLE/EDIT repeatedly until “ERASE?” appears in the main display.



```
ERASE?  
YES? → SET
```

- If the loaded MD has no track, “ERASE?” will not appear.
- If you want to stop this editing process, press CANCEL.

3 Press SET.

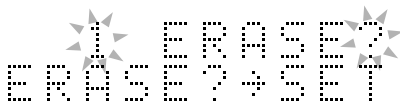

```
1 ERASE?  
ERASE? → SET
```

4 Press ►► or ◀◀ to select the track you want to erase.

- You can select the track using the number buttons. In this case, the selected track starts playing repeatedly.

5 Press SET.

“✓” appears in the main display.
The track marked with “✓” will be erased.



```
✓ NO? → CANCEL  
5 ERASE?
```

Ex.: When track 5 is selected.

- When you do not want to erase the track, press CANCEL to remove “✓”.

6 Repeat steps 4 and 5 to select all the tracks you want to erase.

- You can select up to 15 tracks. If you select a 16th track to erase, “MEMORY FULL” will appear in the main display.

7 Press ENTER.



```
<ERASE>  
YES? → ENTER
```

8 Press ENTER.

“EDITING” appears in the main display for a while, then “WRITING” and the MD REC indicator flash while the editing you have made is being recorded on the MD.

Erasing All Tracks—ALL ERASE

This function allows you to erase all the tracks on an MD.
You cannot resume the erased tracks.

On the remote control ONLY:

In the following example, the process is explained from the very first—that is, inserting a disc. You can also edit an MD during playback (in Normal play mode).

1 Insert an MD you want to edit into the MD loading slot.

2 Press TITLE/EDIT repeatedly until “ALL ERASE?” appears in the main display.



```
ALL ERASE?  
YES? → SET
```

- If you want to stop this editing process, press CANCEL.

3 Press SET.



```
<ALL ERASE>  
YES? → ENTER
```

- To cancel the setting, press CANCEL.

4 Press ENTER.

“EDITING” appears in the main display for a while, then “WRITING” and the MD REC indicator flash while the editing you have made is being recorded on the MD.

“BLANK DISC” appears in the main display.

Assigning Titles to an MD

You can assign a name to each MD, to each group and to each track using alphabetic characters (uppercase and lowercase), symbols and numerals. Once a title is assigned, it is displayed for your confirmation.

- You cannot edit titles composed of more than 64 characters.

About the number of characters entered for an MD

The total number of characters that you can enter for an MD is 1792. The maximum number that you can enter for a disc title is 64, and for each track title, 61. (However, the actual number you can enter may be slightly less than these maximum numbers due to the MD limitations—see page 66.)

- A space can be counted as one character.
- When the stereo long-hour recording (LP2 or LP4, see page 35) method is used for recording, the maximum number you can enter for a track title is automatically reduced since “LP:” and a space are automatically added to the beginning of the track title. Consequently this reduces the total number of characters you can enter for an MD.

Ex.: You can enter up to 10 characters for each track if an MD is composed of 120 tracks recorded using the stereo long-hour recording method.

In the following example, the process is explained from the very first—that is, inserting a disc. If you have already started recording or playing, start from step 2.

- You can edit titles during playback (in Normal play mode).
- To exit from the title entry screen any time during the process, press TITLE/EDIT or GROUP TITLE/EDIT repeatedly.

1 Insert an MD you want to edit into the MD loading slot.

2 Enter the unit into the title entry mode.

For the disc and track title:

Press TITLE/EDIT.

Disc title entry screen appears in the main display.

DISC TITLE?
YES? → SET

For the group title:

Press GROUP TITLE/EDIT.

Group title entry screen appears in the main display.

GR- - TITLE?
YES? → SET

3 Press \rightarrow or \leftarrow to change the title entry mode.

- Each time you press the button, the title entry mode changes as follows:

For the disc and track title:

DISC TITLE? \leftrightarrow 1 TITLE? \leftrightarrow 2 TITLE? \leftarrow
The last track title \leftrightarrow ... \leftrightarrow 3 TITLE? \leftarrow

For the group title:

GR- - TITLE? \rightarrow GR1 TITLE? \leftarrow
The last group title \leftrightarrow ... \leftrightarrow GR2 TITLE? \leftarrow

4 Press SET to enter the unit into the selected title entry mode.

Character entry position
DISC > # a 1
Character set

Ex.: When the disc has no title.

To be continued on the next page \Rightarrow

5 Enter characters.

1) Press DISP/CHARA to select the character set you want.

- Each time you press the button, the character set changes as follows:

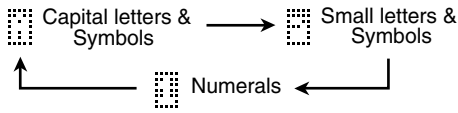

2) Press the character entry button for a character you want to input.

Ex.:

- To enter an "A" or "a," press ABC once.
To enter a "B" or "b," press ABC twice.
To enter a "C" or "c," press ABC three times.
- To enter a symbol, press MARK repeatedly until the mark you want appears.
- To enter a numeral, press 0 – 9.
- To enter a space while entering a title, press \rightarrow twice.
- To move the character entry position while entering a title, press \rightarrow or \leftarrow .*
- If you have entered an incorrect character, press \rightarrow or \leftarrow to select the character you want to correct, then press CANCEL to delete it.

* If you press \leftarrow repeatedly during recording, the entered characters may be displayed incorrectly. In this case, press TITLE/EDIT or GROUP TITLE/EDIT, then repeat from step 2 again.

3) Repeat steps 5 – 1) and 5 – 2) to enter other characters.

- If the character you want to enter next is assigned to the same button you have just pressed in step 5 – 2), press \rightarrow once to move the character entry position to the right.
- The main display can only show 6 characters at a time. If you enter the 7th character, the first character disappears, and so on.

6 Press ENTER to finish the current title entry.

The next title entry screen appears.

- **For the disc title:**
The track title entry screen for the track 1 appears.
- **For the track title:**
The next track title entry screen appears (or the unit exits from the title entry screen if the current track is the last one on the disc).
- **For the group title:**
The next group title entry screen appears (or the same screen still remains if the current group is the last one on the disc).

If you want to go on assigning a name, repeat steps 3 to 6.

7 Press CANCEL to exit from the title entry mode.

- When recording, do not go to the next step until the recording ends.

8 Press MD \blacktriangle on the main unit to eject the MD.

"WRITING" and the MD REC indicator flash while the editing you have made is being recorded on the MD.



You can assign titles during play or recording

• **During play:**

Entering a track title

The MD recorder repeats playback of the current track until you press ENTER in step 6 above. When you press ENTER, the next track will be played.

Entering a disc title

The MD recorder repeats playback of all tracks of the MD until you press ENTER in step 6 above. When you press ENTER, the MD recorder enters the track title entry mode.

Entering a group title

The MD recorder repeats playback of the tracks in the group until you press ENTER in step 6. When you press ENTER, the MD recorder enters the next group title entry mode.

• **During recording:**

Entering a track title

The MD recorder continues recording even after you press ENTER in step 6 above. When you press ENTER, a track title is assigned to the track where you have started the title entry. If you do not press ENTER before recording ends, the track title assigned will be canceled.

• **During CD Synchronized Recording (see page 36):**

You can assign the disc title, and 16 track titles one after another as recording goes on. The track titles you have entered are automatically assigned to the tracks recorded on the MD in sequential order. If you enter 17th track title or more, they are ignored.



When you unplug the AC power cord or if a power failure occurs before step 8

The editing you have made is not recorded on the MD.



Available symbols are as follows:

(Blank)	!	"	#	\$	%	&	'	()
*	+	,	-	.	/	:	;	< =
>	?	@	_	\				

Changing the Title

You can make a correction or change the title.

- 1** Follow steps 1 to 4 on page 56.
- 2** Select the character you want to correct, by pressing \rightarrow or \leftarrow .
 - Make sure that the character you want to change is flashing.
- 3** Press CANCEL to delete the character you have selected in the above step.
- 4** Input the correct character, referring to step 5 on the previous page.
- 5** Repeat steps 2 to 4 of the current procedure to correct more characters.
- 6** Press ENTER to finish correcting the title.
 - If you want to correct another title, select another title entry mode by pressing \rightarrow or \leftarrow , press SET, then repeat from step 2 above.
 - If you want to finish the correction, go to the next step.
- 7** Press MD \blacktriangle on the main unit to eject the MD. "WRITING" and the MD REC indicator flash while the editing you have made is being recorded on the MD.

To erase all the characters, press CANCEL repeatedly in step 3 above to erase all the characters, then go to step 6.

Using the Timers

The buttons emphasized in the illustration below are used and explained in this section (pages 60 to 63).

Remote control

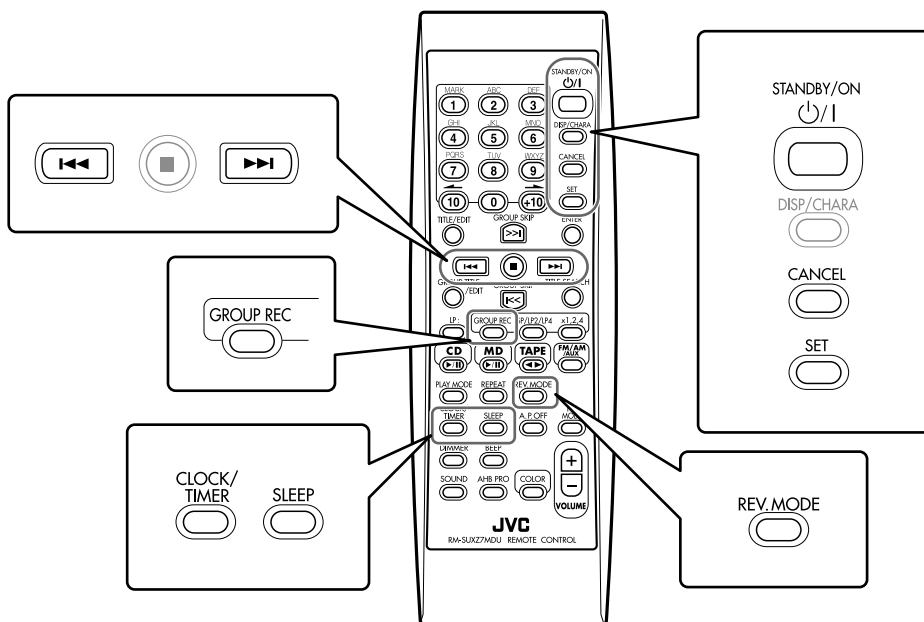

Main unit

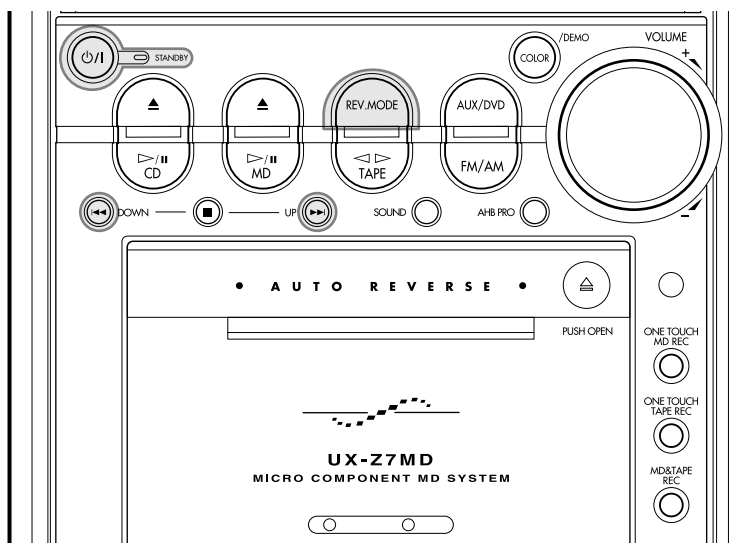

There are three timers available—Recording Timer, Daily Timer and Sleep Timer.

- Before using these timers, make sure the built-in clock is set correctly (see page 12).
- When using the tuner as the source, preset stations in advance (see page 18).

Using Recording Timer

With Recording Timer, you can make an unattended recording.

- You can set Recording Timer whether the unit is turned on or in standby mode.
- To correct a mis-entry any time during the setting process, press CANCEL.
- To exit from the timer setting mode during the setting process, press CLOCK/TIMER repeatedly until the source indication appears.

How Recording Timer actually works

The unit automatically turns on, muting the volume, and starts recording on the MD or on the tape when the timer-on time comes. Then, when the timer-off time comes, the unit automatically turns off (stands by). Recording Timer works only once, but the timer settings remain stored in memory until you reset them or unplug the AC power cord.

1 Press CLOCK/TIMER repeatedly until “REC TIMER” appears in the main display.

The timer (⌚) indicator lights up and the REC indicator starts flashing on the display.

```

REC TIMER
ON? → SET
  ↓
OFF? → CANCEL
  
```

- Each time you press the button, the timer mode change as follows:

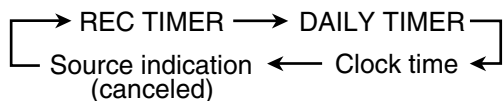

2 Press SET.

The source name flashes in the main display.

3 Select the source to record.

- 1) Press **▶▶** or **◀◀** repeatedly to select the source.
 - Each time you press the button, the source changes as follows:

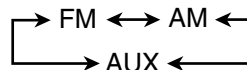

- When you select “FM” or “AM,” press SET, then select a preset number by pressing **▶▶** or **◀◀**.
 - When you select “AUX,” set the timer function of the external component as well.
- 2) Press SET.
The device to be recorded onto flashes in the main display.

4 Select the device to be recorded onto.

- 1) Press **▶▶** or **◀◀** repeatedly to select the device.

```

MD REC ↔ TAPE REC
  
```

- 2) Press SET.
 - When you select “MD REC,” select the recording length mode (see page 36) by pressing **▶▶** or **◀◀**, then press SET again.
 - When you select “TAPE REC,” select the reverse mode (see page 39) by pressing REV.MODE.

The hour digit of the timer-on time starts flashing.

5 Set the timer-on time.

- 1) Press **▶▶** or **◀◀** repeatedly to adjust the hour.
You can adjust the hour using the number buttons.
- 2) Press SET.
The minute digit starts flashing.
- 3) Press **▶▶** or **◀◀** repeatedly to adjust the minute.
You can adjust the minute using the number buttons.

```

REC TIMER
ON 11:30
  
```

Ex.: When you set timer-on time to 11:30.

- 4) Press SET.
The hour digit of the timer-off time starts flashing.

To be continued on the next page ⇒

6 Set the timer-off time.

- 1) Press ►► or ◀◀ repeatedly to adjust the hour.
You can adjust the hour using the number buttons.
- 2) Press SET.
The minute digit starts flashing.
- 3) Press ►► or ◀◀ repeatedly to adjust the minute.
You can adjust the minute using the number buttons.

REC TIMER
OFF 13:00

Ex.: When you set timer-off time to 13:00.

- 4) Press SET.
The REC indicator stops flashing and remains lit.
The contents of this setting appear in the main display for your confirmation.

7 Press STANDBY/ON (or on the main unit) to turn off the unit if necessary.

20 seconds before the timer-on time, the REC indicator and “REC TIMER STANDBY” start flashing on the display.

REC TIMER
STANDBY

To record onto an MD using the Group recording, press GROUP REC to turn on the Group recording after setting the Recording Timer (before turning off the unit).



When you press  while Recording Timer works

The recording stops but the timer function is not canceled. The unit automatically turns off (stands by) when the timer-off time comes.

To turn off the Recording Timer after its setting is done

- 1 Press CLOCK/TIMER repeatedly until “REC TIMER” appears in the main display.
- 2 Press CANCEL.
The timer () and REC indicators go off from the display.

To turn on the Recording Timer again

- 1 Press CLOCK/TIMER repeatedly until “REC TIMER” appears in the main display.
- 2 Press SET repeatedly until the settings are shown in the main display for your confirmation.
The timer () and REC indicators light up on the display.

Using Daily Timer

With Daily Timer, you can wake up to your favorite music or radio program.

- You can set Daily Timer whether the unit is turned on or in standby mode.
- To correct a mis-entry any time during the setting process, press CANCEL.
- To exit from the timer setting mode during the setting process, press CLOCK/TIMER repeatedly until the source indication appears.

How Daily Timer actually works

The unit automatically turns on, and starts playing the specified source when the timer-on time comes. Then, when the timer-off time comes, the unit automatically turns off (stands by).

Daily Timer works every day, and the timer settings remain stored in memory until you reset them or unplug the AC power cord.

1 Press CLOCK/TIMER repeatedly until “DAILY TIMER” appears in the main display.

The timer () indicator lights up and the DAILY indicator starts flashing on the display.

DAILY TIMER
ON? → SET
↕
OFF? → CANCEL

- Each time you press the button, the timer mode change as follows:

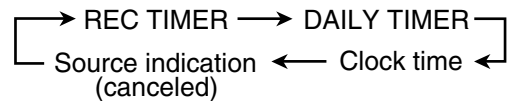

2 Press SET.

The source name flashes in the main display.

3 Select the source to play back.

- 1) Press ►► or ◀◀ repeatedly to select the source.
 - Each time you press the button, the source changes as follows:



- You can also use the source selecting buttons.
 - **When you select “CD,” “MD” or “TAPE,”** prepare it for playing back.
 - **When you select “FM” or “AM,”** press SET, then select a preset number by pressing ►► or ◀◀.
 - **When you select “AUX,”** set the timer function of the external component as well.
- 2) Press SET.
The hour digit of the timer-on time starts flashing.

4 Set the timer-on time.

- 1) Press ►► or ◀◀ repeatedly to adjust the hour.
You can adjust the hour using the number buttons.
- 2) Press SET.
The minute digit starts flashing.
- 3) Press ►► or ◀◀ repeatedly to adjust the minute.
You can adjust the minute using the number buttons.

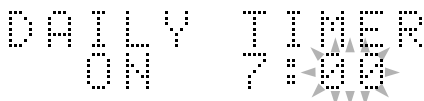

Ex.: When you set timer-on time to 7:00.

- 4) Press SET.
The hour digit of the timer-off time starts flashing.

5 Set the timer-off time.

- 1) Press ►► or ◀◀ repeatedly to adjust the hour.
You can adjust the hour using the number buttons.
- 2) Press SET.
The minute digit starts flashing.
- 3) Press ►► or ◀◀ repeatedly to adjust the minute.
You can adjust the minute using the number buttons.

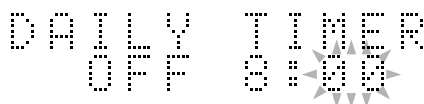

Ex.: When you set timer-off time to 8:00.

- 4) Press SET.
The volume setting appears in the main display.

6 Adjust the volume level.

- 1) Press ►► or ◀◀ repeatedly to adjust the volume level.
 - You can adjust the volume level to “--” or within the range of 0 (silent) to 40 (maximum).
 - When you select “VOLUME --,” the volume is set to the current volume level.



- 2) Press SET.
The DAILY indicator stops flashing and remains lit. The contents of this setting appear in the main display for your confirmation.

7 Press STANDBY/ON (or on the main unit) to turn off the unit if necessary.

20 seconds before the timer-on time, the DAILY indicator and “DAILY TIMER STANDBY” start flashing on the display.

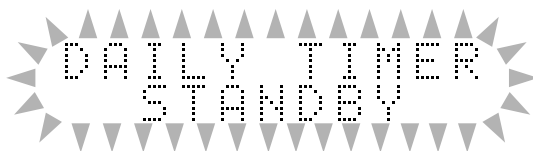

To turn off the Daily Timer after its setting is done

- 1 Press CLOCK/TIMER repeatedly until “DAILY TIMER” appears in the main display.
- 2 Press CANCEL.
The timer (⌚) and DAILY indicators go off from the display.

To turn on the Daily Timer again

- 1 Press CLOCK/TIMER repeatedly until “DAILY TIMER” appears in the main display.
- 2 Press SET repeatedly until the settings are shown in the main display for your confirmation.
The timer (⌚) and DAILY indicators light up on the display.



notes If the unit is kept turned on when the timer-on time comes

Daily Timer does not work at all.



notes Daily Timer will be canceled and the unit will not turn off automatically in the following cases:

- When you change the source.
- When you enter the MD editing or title entry mode.
- When you turn off the Daily Timer (see above).

Using Sleep Timer

With Sleep Timer, you can fall asleep to your favorite music.

- You can set Sleep Timer when the unit is turned on.

How Sleep Timer actually works

The unit automatically turns off after the specified time length passes.

On the remote control ONLY:

1 Press SLEEP.

The timer (⌚) and SLEEP indicators start flashing on the display.

“SLEEP 10” appears in the main display for a while.



- Each time you press the button, the time length changes as follows:

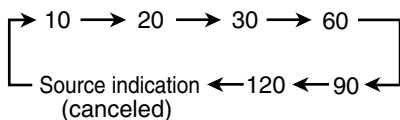

2 Press SET or wait for about 5 seconds.

The illumination of the electronic swing panel and display window dim.

The timer (⌚) and SLEEP indicators stop flashing and remain lit.

To check the remaining time until the shut-off time, press SLEEP once. The remaining time until the shut-off time appears for about 5 seconds.

To change the shut-off time, press SLEEP repeatedly until the time length you want appears.

To cancel the setting, press SLEEP repeatedly until the current source indication appears in the main display. The timer (⌚) and SLEEP indicators go off.



Sleep Timer will be also canceled in the following cases:

- When you turn off the unit.
- When you operate other timer settings.
- When you adjust the clock.

To sleep with the Sleep Timer and wake up with the Daily Timer

The unit turns off when the shut-off time comes (set by the Sleep Timer), and turns on when the timer-on time (set by the Daily Timer) comes.

- 1 Set the Daily Timer as explained on pages 61 and 62.
- 2 Start playing back any source you want to listen to before sleep.
- 3 Set the Sleep Timer.

Timer Priority

Since each timer can be set separately, you may wonder what happens if the setting for these timers overlaps. Here are the priorities for each timer.

- **A timer with the late timer-on time has priority.**

If Recording Timer is set to come on while Daily Timer is operating, Daily Timer is canceled.

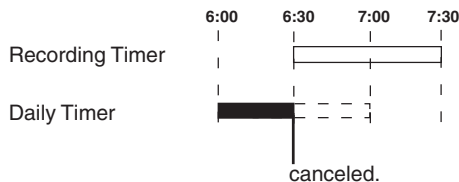

If Recording Timer is set to come on while Sleep Timer is operating, Sleep Timer will not shut off the power even if the shut-off time comes.

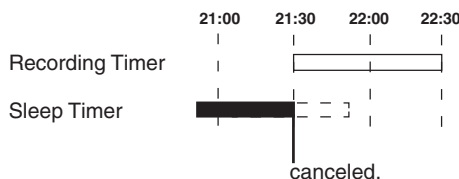

Sleep timer and Auto Power Off (see page 11) can be used at the same time.

Maintenance

To get the best performance of the unit, keep your discs, tapes and mechanism clean.

General Notes

In general, you will have the best performance by keeping your CDs, MDs and the mechanism clean.

- Store CDs and MDs in their cases, and keep them in cabinets or on shelves.
- Keep the electronic swing panel closed when not in use.

Cleaning the unit

• Stains on the unit

Should be wiped off with a soft cloth. If the unit is heavily stained, wipe it with a cloth soaked in water-diluted neutral detergent and wrung well, then wipe clean with a dry cloth.

• Since the unit may deteriorate in quality, become damaged or get its paint peeled off, be careful about the following:

- DO NOT wipe it with a hard cloth.
- DO NOT wipe it strong.
- DO NOT wipe it with thinner or benzine.
- DO NOT apply any volatile substance such as insecticides to it.
- DO NOT allow any rubber or plastic to remain in contact with it for a long time.

Handling CDs



- Remove the CD from its case by holding it at the edge while pressing the center hole lightly.
- Do not touch the shiny surface of the disc, or bend the CD.
- Put the CD back in its case after use to prevent warping.

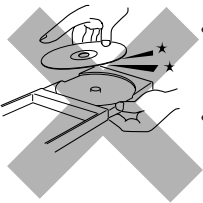

- Be careful not to scratch the surface of the CD when placing it back in its case.
- Avoid exposure to direct sunlight, temperature extremes, and moisture.



To clean the CD

Wipe the CD with a soft cloth in a straight line from center to edge.



DO NOT use any solvent—such as conventional record cleaner, spray, thinner, or benzine—to clean the CD.

Handling MDs

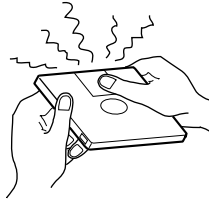

- Do not open the shutter.
 - The shutter is locked so that it will not open. Trying to force it open will break the MD. If the shutter opens accidentally, close it again quickly without touching the MD inside.

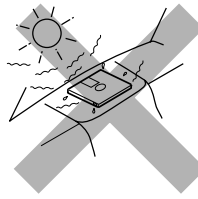

- Do not place MDs in the following places:
 - High temperature areas such as in direct sunlight or inside a car.
 - High humidity areas, e.g. in a bathroom.
 - On a beach or sandy area.

• Clean MDs regularly.

- If dust or dirt gets on cartridge, wipe it off with a soft dry cloth.

Handling cassette tapes

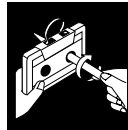

- If the tape is loose in its cassette, take up the slack by inserting a pencil in one of the reels and rotating.
- If the tape is loose, it may get stretched, cut, or caught in the cassette.



- Be careful not to touch the tape surface.



- Avoid the following places to store the tape:
 - In dusty places
 - In direct sunlight or heat
 - In moist areas
 - On a TV or speaker
 - Near a magnet

Additional Information

MD Disc Types

There are two types of MDs: Premastered (pre-recorded) and Recordable (blank).

Premastered MDs

Premastered MDs, which have been recorded at music studio, can be played back like regular CDs. On an MD of this type, data is recorded as the presence or absence of tiny pits. A laser beam focuses on the pits on the surface of the MD and reflects the detection back to the lens in the MD recorder. The MD recorder then decodes the signals and plays them back as music. This type of MD is called an “optical disc.”

Recordable MDs

Recordable MDs, which use magneto-optical technology, can be recorded and played back repeatedly. The laser inside the MD recorder applies heat to the MD, demagnetizing the magnetic layer of the MD for recording and playback. This type of MD is called an “magnetic-optical disc.”

ATRAC (Adaptive Transform Acoustic Coding)/ATRAC3 (MDLP)

The MD provides 80 minute recording and playback time, much more than an audio CD, but in a diameter of only 64 mm. This ability to store such a large amount of data is the result of ATRAC, an audio compression technique developed for MD. This technology cuts out faint sounds that would not be heard by the human beings. This technology, based on human sensitivity to sounds, reduces recorded data volume up to about one-fifth of the original data volume.

Furthermore, this unit takes advantage of the latest ATRAC3 techniques, which can reduce the amount of data to record to one-tenth or one-twentieth of the original data volume. This allows for 2 times or 4 times long-hour stereo recording on this unit.

UTOC (User Table Of Contents)

Found only on recordable MDs, this area contains sub-data (track number, recording data, etc.) which can be rewritten by the user.

UTOC enables us to search for tracks quickly and edit tracks on the MD.

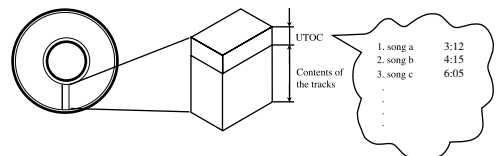

Sound Skip Guard Memory

The biggest weakness of discs is their susceptibility to vibration. The “Sound Skip Guard Memory” has been developed to cope with this weakness.

With this function, a few seconds of signals read by the optical read head from the MD are first stored in memory before being reproduced as audio signals. Thus, even when vibration or shock interrupts signals being read, these stored signals can continue to reproduce sounds for the few seconds. Thus, the user will enjoy uninterrupted music.

Normally....

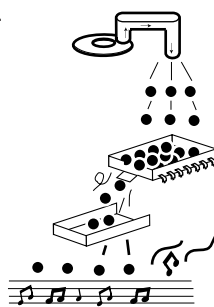

When “vibrated”....

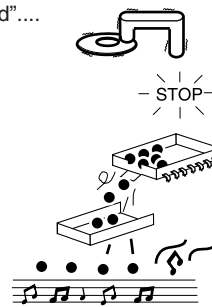

SCMS (Serial Copy Management System)

The MD recorder integrated to this unit uses the Serial Copy Management System which allows only first-generation digital copies to be made of premastered software (like CDs or prerecorded MDs).

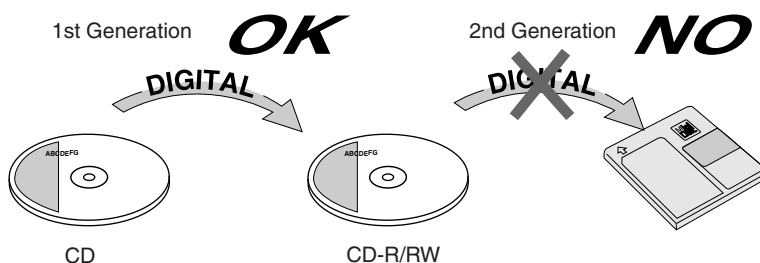

HCMS (High-speed Copy Management System)

Now onto recordable MDs (minidisks), you can record (copy) sound at a recording speed exceeding the normal speed. This fact requires some restrictions for protecting copyrights.

On this unit, you cannot re-record, at either high speed or normal speed, a song (track) that has been recorded once from a CD at high speed, until 74 minutes elapse after the first recording of the song started.

For example, after having recorded the first song (track) of a CD at high speed, you cannot record it again, at either high speed or normal speed, until 74 minutes elapse after the first recording of that song started.

MD limitations

The MD records data in an original format that differs from that of conventional cassette tapes or DATs. Since there are some limitations with this recording format, the following types of symptoms may occur. These symptoms are not malfunctions.

Symptoms	Cause
"DISC FULL" appears, even though there is still enough remaining time on an MD.	There is a maximum number of tracks which can be recorded, regardless of recording time. More than 254 tracks cannot be recorded on an MD.
"DISC FULL" appears, even though the number of tracks and recording time do not reach the limit.	<ul style="list-style-type: none"> Repeating erasure and recording on the same MD creates many blank portions sparsely on the MD. When recording on such an MD, a track is recorded on these blank portions sparsely. If a track is divided and recorded into so many portions, "DISC FULL" appears. If a divided portion of less than 8 seconds is made while a track is recorded on the MD, that track cannot be joined to another track using the JOIN function. Furthermore, if that track is erased, the remaining time of the MD may not increase exactly by the erased amount. If a track has been divided into many portions while being recorded on the MD, sounds will drop out while fast forwarding or reversing such an MD.
The JOIN function sometimes does not work.	
The remaining time on the MD does not increase even when tracks are erased.	
The sound drops out during fast forward or fast reverse.	
The amount of recorded time on the MD added to the amount of remaining time is shorter than the MD's total possible recording time.	

CD/MD Messages

For CD:

Message	Signification	Solution
CANNOT PLAY	You are trying to play back a CD which cannot be played or there is a problem with the CD.	Change the CD.
CD NO DISC	<ul style="list-style-type: none"> No disc is on the disc tray. You are trying to play back a CD-R/RW which has not been "finalized." 	<ul style="list-style-type: none"> Place a disc on the disc tray. This is not a malfunction. You can play back "finalized" CD-R/RWs.
CANNOT REC x1 REC ONLY	You are trying to record a CD onto a MD and a tape at the same time using x2 or x4 speed recording.	This is not a malfunction. Select normal recording speed (x1). (See page 40.)

For MD:

Message	Signification	Solution
BLANK DISC	The disc is blank.	Change the MD if you want to enjoy playback.
CANNOT ENTRY!	The track has already been in the selected group.	This is not a malfunction. (See "Adding a Track to a Group—ENTRY GR" on page 45.)
CANNOT FORM!	You are trying to form a new group including other groups.	This is not a malfunction. (See "Forming a Group—FORM GR" on page 44.)
CANNOT GROUP!	There is no more space for storing information concerning MD group.	You cannot form a group any more on the MD.
CANNOT JOIN	You are trying to join tracks (shorter than 8 seconds) or groups which cannot be joined.	This is not a malfunction. (See pages 47, 53 and 66.)
CANNOT LISTEN	You are trying to listen to the sound during high-speed recording.	This is not a malfunction. You cannot listen to the sound during high-speed recording.
CANNOT TITLE	You are trying to enter the title on the MD which already has over 1 792 characters in total.	This is not a malfunction. (See "Assigning Titles to an MD" on page 56.)
CANNOT REC x1 or x2 ONLY	You are trying to record a CD in program play or random play mode using x4 speed recording.	This is not a malfunction. Select other recording speeds. (See page 36.)
READ ERROR	The UTOC fails to be read.	Turn off the unit, then turn on it again.
DISC FULL	There is no more space on the MD or there are over 254 tracks.	Use another recordable MD or erase some tracks.
DISC PROTECTED	MD is write-protected.	Unprotect the MD or use another. (See page 34.)

Message	Signification	Solution
EMERGENCY STOP	A malfunction has occurred during recording.	Stop playback, and eject the MD and re-insert it.
GROUP FULL	You are trying to form over 99 groups.	This is not a malfunction. There can be up to 99 groups on an MD.
GROUP TRACK	You are trying to make a group by including a track which belongs to another group.	This is not a malfunction. (See “Forming a Group—FORM GR” on page 44.)
HCMS CANNOT COPY	You are trying to re-record a song that has been recorded once at high speed, before 74 minutes have passed after its first recording.	An internal timer works to protect copyrights. Wait for 74 minutes or more, then start recording.
LOAD ERROR	MD is not loaded correctly.	Eject the MD and re-insert it.
MD NO DISC	There is no MD.	Put an MD.
NON AUDIO CAN NOT COPY	You are trying to copy a non-audio disc like a CD-ROM or Video CD.	Stop recording.
PLAYBACK DISC	You are trying to edit or record on a playback-only MD.	Use a recordable MD.
SCMS CANNOT COPY	Digital copy of the 2nd generation is prohibited.	You cannot make a digital recording from a duplicated CD-R/RW onto an MD. If you try to do so, the unit will automatically convert the digital signals to analog signals and record them at x1 speed (normal speed).
LOW TEMP CANNOT COPY	The room temperature is too low to record using x4 speed recording.	This is not a malfunction. You can record using x4 speed recording within 5°C – 35°C.

Troubleshooting

If you are having a problem with your unit, check this list for a possible solution before calling for service.

If you cannot solve the problem from the hints given here, or the unit has been physically damaged, call a qualified person, such as your dealer, for service.

Symptom	Possible Cause	Action
No sound is heard from the speakers.	<ul style="list-style-type: none"> • Connections are incorrect or loose. • A pair of headphones is connected. 	<ul style="list-style-type: none"> • Check all connections and make corrections. (See pages 6 – 9.) • Unplug the headphones from the PHONES jack.
Unable to record on an MD.	<ul style="list-style-type: none"> • You are using a prerecorded MD. • The MD is write-protected. 	<ul style="list-style-type: none"> • Change it with a recordable MD. • Unprotect the MD. (See page 34.)
Poor radio reception.	<ul style="list-style-type: none"> • The antenna is not connected correctly. • The AM loop antenna is too close to the unit. • The FM antenna is not properly extended and positioned. 	<ul style="list-style-type: none"> • Reconnect the antenna securely. • Change the position and direction of the AM loop antenna. • Extend FM antenna to the best reception position.
Unable to operate the remote control.	<ul style="list-style-type: none"> • The path between the remote control and the remote sensor on the unit is blocked. • The batteries have lost their charge. • You are using the remote control far from the main unit. 	<ul style="list-style-type: none"> • Remove the obstruction. • Replace the batteries. (See page 9.) • Signals cannot reach the remote sensor. Move close to the main unit.
Loaded CD and MD can not be ejected.	<ul style="list-style-type: none"> • The main AC power cord is not plugged in. • The Disc Lock function is in use. 	<ul style="list-style-type: none"> • Plug in the AC power plug. • Cancel the Disc Lock function. (See page 25.)
The CD does not play.	The CD is upside down.	Put the CD in with the label side up.
The CD skips.	The CD is dirty or scratched.	Clean or replace the CD. (See page 64.)
The cassette holder does not open or close.	Power supply from the AC power cord has been cut off while the tape was running.	Turn on the unit.
Impossible to record on a tape.	Small tabs on the back of the cassette are removed.	Cover the holes with adhesive tape.
Operations are disabled.	The built-in microprocessor has malfunctioned due to external electrical interference.	Unplug the unit then plug it back in.

Specifications

Design and specifications are subject to change without notice.

Amplifier Section—CA-UXZ7MD

Output Power (IEC 268-3):	46 W (23 W + 23 W) at 4 Ω (MAX.) 40 W (20 W + 20 W) at 4 Ω (10 % THD)
Audio input sensitivity/Impedance (at 1 kHz)	
AUX/DVD:	400 mV/47 k Ω (at “LEVEL 1”) 200 mV/47 k Ω (at “LEVEL 2”)
Speaker Terminals:	4 Ω – 16 Ω

Tuner

FM tuning range:	87.50 MHz—108.00 MHz
AM tuning range:	531 kHz—1 710 kHz

CD player

CD Capacity:	1 CD
Dynamic range:	88 dB
Signal-to-noise ratio:	95 dB
Wow and flutter:	Immeasurable

MD recorder

Audio playing system:	MiniDisc digital audio system
Recording system:	Magneto-optical overwrite system
Reading system:	Non-contact, semiconductor laser pickup ($\lambda=780$ nm)
Error correction system:	CIRC (Cross Interleave Reed-Solomon Code)
Recording/Playback time (when using a 80-minute MD)	
SP:	80 minutes
LP2:	160 minutes
LP4:	320 minutes
Sampling frequency:	44.1 kHz
Audio compression system:	ATRAC (Adaptive TRansform Acoustic Coding)/ATRAC3 (MDLP)

Cassette deck

Frequency response:	
Normal (type I):	60 Hz—14 000 Hz
Wow and flutter:	0.15 % (WRMS)

General

Power requirement:	AC 240 V \sim , 50 Hz
Power consumption:	At operation: 65 W On standby: 13 W 1.4 W (in power save mode)
Dimensions (approx.):	185 mm x 265 mm x 316 mm (W/H/D)
Mass (approx.):	5.9 kg

Supplied accessories

See “Unpacking” on page 6.

Speaker Section—SP-UXZ7MD

Type:	2-way bass-reflex type
Speakers:	Woofer 11 cm cone x1, Tweeter 4 cm cone x1
Power handling capacity:	35 W
Impedance:	4 Ω
Frequency range:	55 Hz to 20 kHz
Sound pressure level:	82 dB/W•m
Dimensions (approx.):	145 mm x 265 mm x 215 mm (W/H/D)
Mass (approx.):	2.2 kg each

US and foreign patents licensed from Dolby Laboratories.

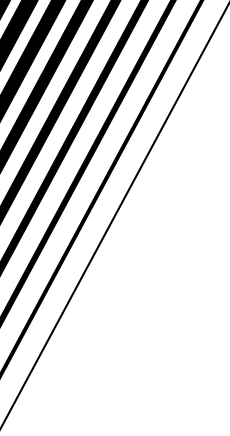

JVC
VICTOR COMPANY OF JAPAN, LIMITED

